



# PRODUCT CATALOGUE

## SAUNA & STEAM





SAW

# Table of Contents

## *Finnish Sauna*

### *Sauna Heaters*

<b>Tower Series</b> .....	1	<b>Stone Series</b> .....	61
SAWO30 Heaters .....	2	Nimbus .....	62
Tower Heaters .....	10	Nimbus Combi .....	63
Aries Heaters .....	18	Culumbus .....	64
Cubos Heater .....	26	Heater Accessories .....	65
Phoenix Heater .....	29	<b>Controls</b> .....	66
Heaterking .....	31	Saunova Heater Controls .....	67
Fiberjungle .....	34	Innova Heater Controls .....	68
<b>Floor Series</b> .....	35	<b>Sauna Accessories</b> .....	71
Helius .....	36	Pails & Ladles .....	72
Taurus .....	38	Thermometers & Combined meters .....	75
Krios Floor .....	40	Clocks & Timers .....	76
Savonia .....	41	Benches, Hangers, Mats & Sauna Lights .....	77
Savonia Combi .....	42	Door Handles, & Miscellaneous Items .....	78
Nordex Floor .....	43	Door Sets .....	79
Nordex S .....	44	Kivistone .....	81
Nordex S Combi .....	45	<b>Steam Sauna</b> .....	82
<b>Wall-Mounted Series</b> .....	46	STW-E Steam Generator .....	83
Mini, Mini X & Mini Combi .....	47	STW Steam Generator .....	84
Scandia .....	49	Steam Generator Controls .....	86
Scandia Combi .....	50		
Krios .....	51		
Nordex .....	53		
Nordex Combi .....	54		
Nordex Mini .....	55		
Nordex Mini Combi .....	56		
Scandifire .....	58		
Minidragon .....	59		



# SAUNA Heaters

With over 30 years of experience on making sauna products, SAWO offers large variety of tower, stone, wall-mounted, floor and combi heaters.

Start by defining the size of your sauna, choose the right kW and controlling option. Anything else is up to your preference of what kind of *löyly* you are looking for and the style of the heater.

# TOWER Series

SAWO Tower heater is best described as a "sauna stone pillar." Strong, stainless steel rings hold massive amounts of stones. The design is developed to produce steam from the lowest to the highest part of the sauna room.



# SAWO30 Heaters

NEW!

**SAWO30 Heaters** are created to celebrate the 30 years journey of SAWO brand. Choose between Round, Corner or Wall model. Designed with precision and elegance, SAWO30 combines robust performance with a sleek, modern aesthetic, making it a centerpiece of any sauna. It's tall structure provides even heat from the bottom to the top.

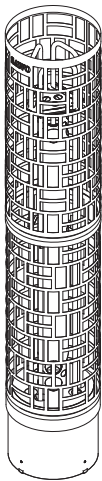

Round

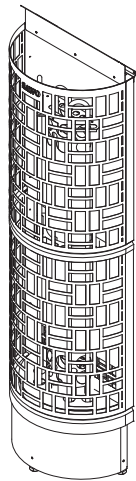

Wall

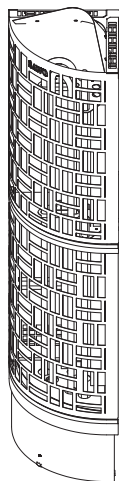

Corner

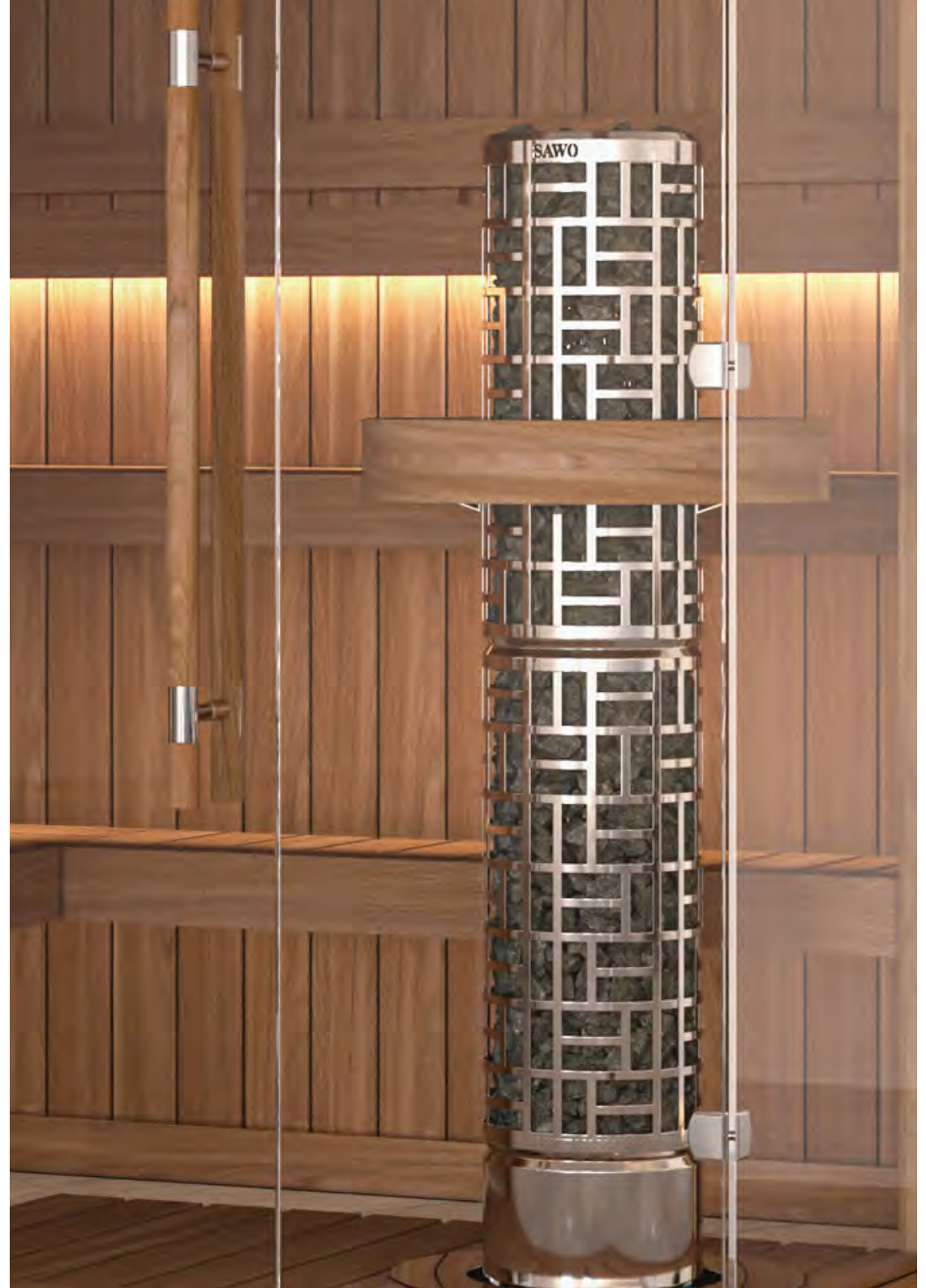



## SAWO30 Round

- » Power Range: 4.5 – 24.0kW
- » Available controlling Ni2, NS and NB
- » Sauna Experience: Mild smooth heat, Humid
- » Casing in stainless or black steel
- » Easier loading of stones with separating middle part.
- » Removable stone spacer, choose between faster heating time and hotter heat or slower, milder heat.
- » Optional heater guard and integrated collar



## SAWO30 Wall

- » Power Range: 4.5 – 24.0kW
- » Available controlling Ni2, NS and NB
- » Sauna Experience: Mild smooth heat, Humid
- » Casing In stainless or black steel
- » Easier loading of stones with separating middle part.
- » Removable stone spacer, choose between faster heating time and hotter heat or slower, milder heat.
- » Optional heater guard and integrated collar



## SAWO30 Corner

- » Power Range: 4.5 – 12.0kW
- » Available controlling Ni2, NS and NB
- » Sauna Experience: Mild smooth heat, Humid
- » Casing In stainless or black steel
- » Easier loading of stones with separating middle part.
- » Removable stone spacer, choose between faster heating time and hotter heat or slower, milder heat.
- » Optional heater guard and integrated collar



# SAWO30 Round

NEW!

**SAWO30 Round** is a magnificent looking heater that is perfect to be placed in the middle of the sauna or embedded into benches.

The large amount of stones in the tall sleek body enables rich, steam-infused atmosphere with an ideal combination of steam and humidity.







SAWO30 Round (Ni2)      SAWO30 Round Black (Ni2)



SAWO30 Round (NS)      SAWO30 Round Black (NS)



SAWO30 Round (NB)      SAWO30 Round Black (NB)

Ni2

HEATER MODEL	kW	SAUNA ROOM		SIZE OF HEATER			STONES		CONTROL	MINIMUM SAFETY DISTANCES	
		MIN (m²)	MAX	WIDTH (mm)	DEPTH (mm)	HEIGHT (mm)	Without Stone Spacer	With Stone Spacer (kg)		A	B
SW3-45Ni2-P-C   SW3-45Ni2-BL-P-C	4,5	3	6	243	243	1305	80	60	Saunova 2.0	100	1900
SW3-60Ni2-P-C   SW3-60Ni2-BL-P-C	6,0	5	8	243	243	1305	80	60	Saunova 2.0	100	1900
SW6-90Ni2-P-C   SW6-90Ni2-BL-P-C	9,0	8	15	344	344	1305	160	105	Saunova 2.0	100	1900

Separate Control

HEATER MODEL	kW	SAUNA ROOM		SIZE OF HEATER			STONES		CONTROL	MINIMUM SAFETY DISTANCES	
		MIN (m²)	MAX	WIDTH (mm)	DEPTH (mm)	HEIGHT (mm)	Without Stone Spacer	With Stone Spacer (kg)		A	B
SW3-45NS-P-C   SW3-45NS-BL-P-C	4,5	3	6	243	243	1305	80	60	separate	100	1900
SW3-60NS-P-C   SW3-60NS-BL-P-C	6,0	5	8	243	243	1305	80	60	separate	100	1900
SW6-90NS-P-C   SW6-90NS-BL-P-C	9,0	8	15	344	344	1305	160	105	separate	100	1900
SW6-120NS-P   SW6-120NS-BL-P	12,0	11	18	344	344	1305	160	100	separate	100	2100
SW12-180NS-P   SW12-180NS-BL-P	18,0	18	30	514	514	1305	250	165	separate	100	2300
SW12-210NS-P   SW12-210NS-BL-P	21,0	22	35	514	514	1305	250	165	separate	100	2300
SW12-240NS-P   SW12-240NS-BL-P	24,0	24	40	514	514	1305	250	165	separate	100	2300

Built-in Control

HEATER MODEL	kW	SAUNA ROOM		SIZE OF HEATER			STONES		CONTROL	MINIMUM SAFETY DISTANCES	
		MIN (m²)	MAX	WIDTH (mm)	DEPTH (mm)	HEIGHT (mm)	Without Stone Spacer	With Stone Spacer (kg)		A	B
SW3-45NB-P-C   SW3-45NB-BL-P-C	4,5	3	6	243	243	1305	80	60	8+4h	100	1900
SW3-60NB-P-C   SW3-60NB-BL-P-C	6,0	5	8	243	243	1305	80	60	8+4h	100	1900
SW6-90NB-P-C   SW6-90NB-BL-P-C	9,0	8	15	540	540	1305	160	105	8+4h	100	1900

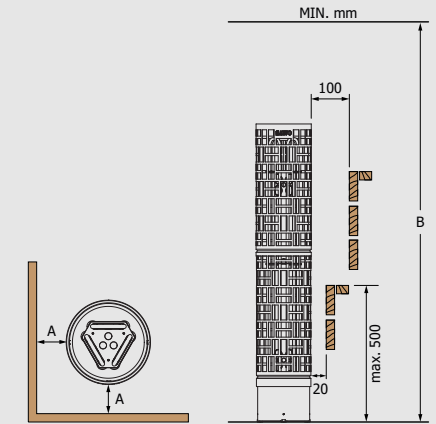

Minimum Safety Distances

Heater Accessories (Optional)

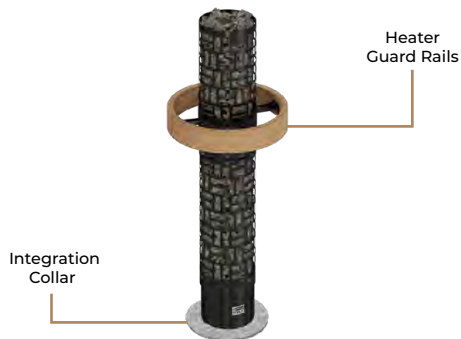

Integration Collars for Round



Stainless



Wooden Cedar (D) & Aspen (A)



Soapstone

MODEL	SIZE OF COLLAR (mm)		
	WIDTH	DEPTH	HEIGHT
TH-COLLAR-ST2	470	470	70
TH-COLLAR-ST6	665	665	60
TH-COLLAR-ST12	830	830	70

MODEL	SIZE OF COLLAR (mm)		
	WIDTH	DEPTH	HEIGHT
TH-COLLAR-W2-D   A	449	187	150
TH-COLLAR-W6-D   A	547	215	150
TH-COLLAR-W12-D   A	694	258	150

MODEL	SIZE OF COLLAR (mm)		
	WIDTH	DEPTH	HEIGHT
TH-COLLAR-S2	507	507	45
TH-COLLAR-S6	620	620	45
TH-COLLAR-S12	790	790	45

Heater Guards for Round

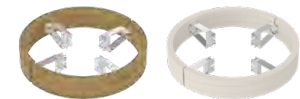

Wooden Cedar (D) & Aspen (A)

MODEL	SIZE OF GUARD RAIL (mm)	
	WIDTH	DEPTH
SW-GUARD-W2-D   A	507	45
SW-GUARD-W6-D   A	620	45
SW-GUARD-W12-D   A	790	45

HEATERS
SW3
SW6
SW12

# SAWO30 Wall

NEW!

**SAWO30 Wall** is perfect for saving space, with remaining very easy on the eyes.

The large amount of stones in the tall sleek body enables rich, steam-infused atmosphere with an ideal combination of steam and humidity.





SAWO30 Wall (Ni2)



SAWO30 Wall Black (Ni2)



SAWO30 Wall (NS)



SAWO30 Wall Black (NS)



SAWO30 Wall (NB)



SAWO30 Wall Black (NB)

Ni2

HEATER MODEL	kW	SAUNA ROOM (m³)		SIZE OF HEATER (mm)			STONES (kg)		CONTROL	MINIMUM SAFETY DISTANCES (mm)	
		MIN	MAX	WIDTH	DEPTH	HEIGHT	Without Stone Spacer	With Stone Spacer		A	B
SW3-45Ni2-WL-P-C   SW3-45Ni2-WL-BL-P-C	4,5	3	6	390	210	1375	80	60	Saunova 2.0	100	1900
SW3-60Ni2-WL-P-C   SW3-60Ni2-WL-BL-P-C	6,0	5	8	390	210	1375	80	60	Saunova 2.0	100	1900
SW6-90Ni2-WL-P-C   SW6-90Ni2-WL-BL-P-C	9,0	8	15	540	290	1375	120	90	Saunova 2.0	100	1900

Separate Control

HEATER MODEL	kW	SAUNA ROOM (m³)		SIZE OF HEATER (mm)			STONES (kg)		CONTROL	MINIMUM SAFETY DISTANCES (mm)	
		MIN	MAX	WIDTH	DEPTH	HEIGHT	Without Stone Spacer	With Stone Spacer		A	B
SW3-45NS-WL-P-C   SW3-45NS-WL-BL-P-C	4,5	3	6	390	*210	1375	80	60	separate	100	1900
SW3-60NS-WL-P-C   SW3-60NS-WL-BL-P-C	6,0	5	8	390	*210	1375	80	60	separate	100	1900
SW6-90NS-WL-P-C   SW6-90NS-WL-BL-P-C	9,0	8	15	540	*290	1375	160	105	separate	100	1900
SW6-120NS-WL-P   SW6-120NS-WL-BL-P	12,0	11	18	540	*290	1375	160	105	separate	100	2100
SW12-180NS-WL-P   SW12-180NS-WL-BL-P	18,0	18	30	780	*430	1375	250	165	separate	100	2300
SW12-210NS-WL-P   SW12-210NS-WL-BL-P	21,0	22	35	780	*430	1375	250	165	separate	100	2300
SW12-240NS-WL-P   SW12-240NS-WL-BL-P	24,0	24	40	780	*430	1375	250	165	separate	100	2300

\*Depth when installed to the wall.

Built-in Control

HEATER MODEL	kW	SAUNA ROOM (m³)		SIZE OF HEATER (mm)			STONES (kg)		CONTROL	MINIMUM SAFETY DISTANCES (mm)	
		MIN	MAX	WIDTH	DEPTH	HEIGHT	Without Stone Spacer	With Stone Spacer		A	B
SW3-45NB-WL-P-C   SW3-45NB-WL-BL-P-C	4,5	3	6	390	210	1375	80	60	built-in	100	1900
SW3-60NB-WL-P-C   SW3-60NB-WL-BL-P-C	6,0	5	8	390	210	1375	80	60	built-in	100	1900
SW6-90NB-WL-P-C   SW6-90NB-WL-BL-P-C	9,0	8	15	540	290	1375	160	105	built-in	100	1900

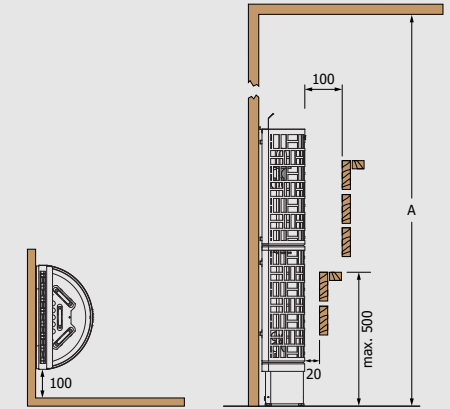

Minimum Safety Distances

Heater Accessories (Optional)

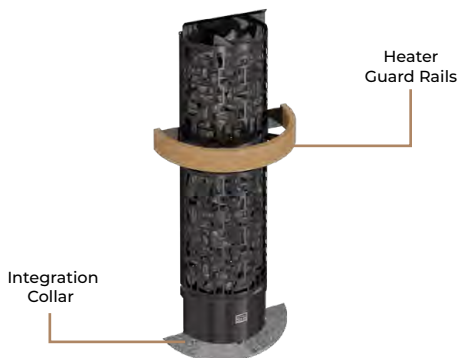

Integration Collars for Wall



Stainless



Wooden Cedar (D) & Aspen (A)



Soapstone

MODEL	SIZE OF COLLAR (mm)	WIDTH	DEPTH	HEIGHT
TH-COLLAR-ST2-WL	665	365	70	
TH-COLLAR-ST6-WL	640	640	42	
TH-COLLAR-ST12-WL	1020	543	70	

MODEL	SIZE OF COLLAR (mm)	WIDTH	DEPTH	HEIGHT
TH-COLLAR-W2-WL-D   A	342	144	150	
TH-COLLAR-W6-WL-D   A	422	155	150	
TH-COLLAR-W12-WL-D   A	540	170	150	

MODEL	SIZE OF COLLAR (mm)	WIDTH	DEPTH	HEIGHT
TH-COLLAR-S2-WL	270	150	140	
TH-COLLAR-S6-WL	280	195	45	
TH-COLLAR-S12-WL	416	238	138	

Heater Guards for Wall



Wooden Cedar (D) & Aspen (A)

MODEL	SIZE OF GUARD RAIL (mm)	WIDTH	DEPTH
SW-GUARD-W2-WL-D   A	615	330	
SW-GUARD-W6-WL-D   A	795	405	
SW-GUARD-W12-WL-D   A	1034	549	

HEATERS
SW3
SW6
SW12

# SAWO30 Corner

NEW!

Choose **SAWO30 Corner** to sauna layouts with tight on space.

The large amount of stones in the tall sleek body enables rich, steam-infused atmosphere with an ideal combination of steam and humidity.

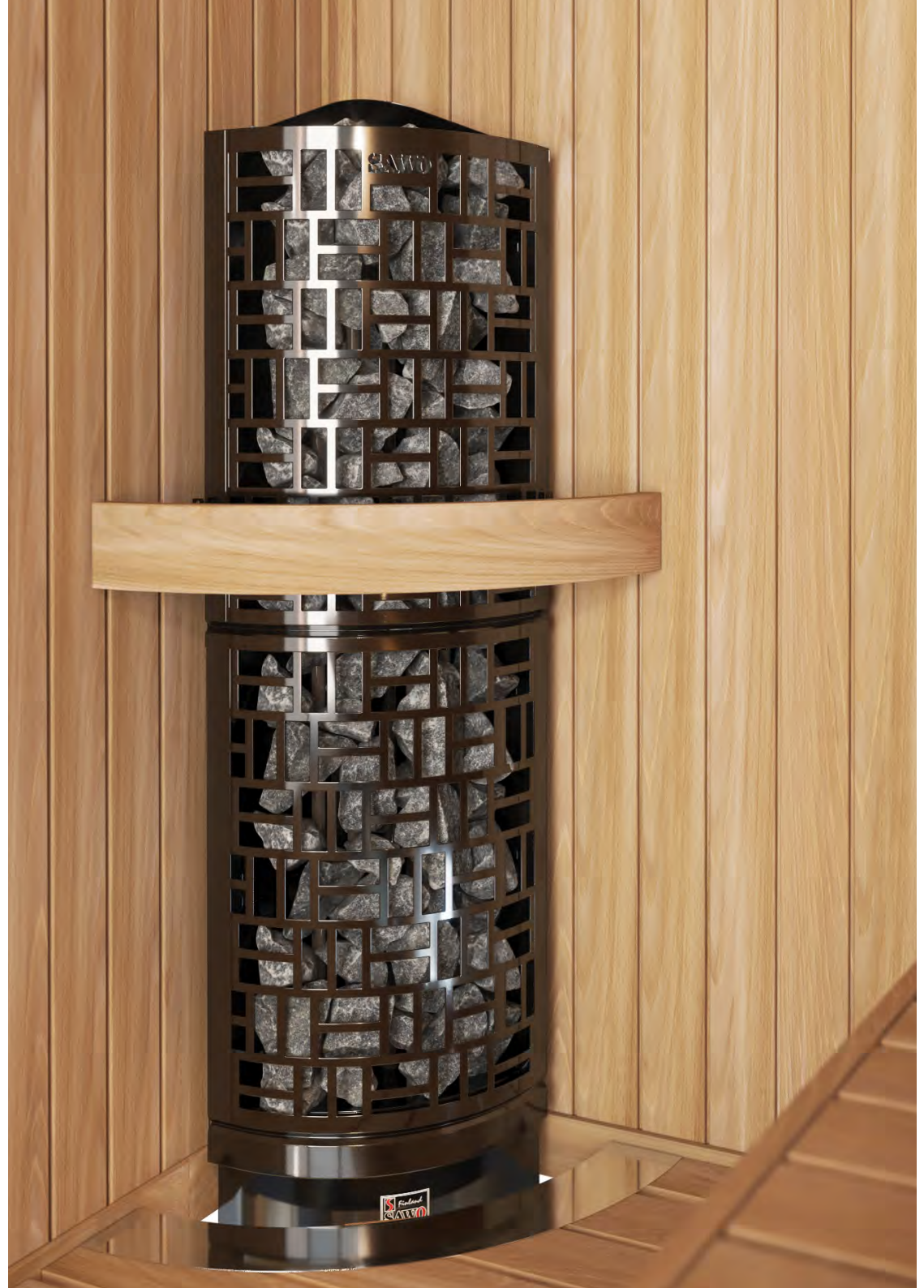



SAWO30 Corner (Ni2)



SAWO30 Corner Black (Ni2)

Ni2

HEATER MODEL	kW	SAUNA ROOM		SIZE OF HEATER			STONES		CONTROL	MINIMUM SAFETY DISTANCES	
		MIN (m³)	MAX	WIDTH	DEPTH	HEIGHT	Without Stone Spacer (kg)	With Stone Spacer		A	B
SW3-45Ni2-CNR-P-C   SW3-45Ni2-CNR-BL-P-C	4,5	3	6	295	*295	1375	70	45	Saunova 2.0	100	1900
SW3-60Ni2-CNR-P-C   SW3-60Ni2-CNR-BL-P-C	6,0	5	8	295	*295	1375	70	45	Saunova 2.0	100	1900
SW6-90Ni2-CNR-P-C   SW6-90Ni2-CNR-BL-P-C	9,0	8	15	410	*410	1375	160	100	Saunova 2.0	100	1900



SAWO30 Corner (NS)



SAWO30 Corner Black (NS)

Separate Control

HEATER MODEL	kW	SAUNA ROOM		SIZE OF HEATER			STONES		CONTROL	MINIMUM SAFETY DISTANCES	
		MIN (m³)	MAX	WIDTH	DEPTH	HEIGHT	Without Stone Spacer (kg)	With Stone Spacer		A	B
SW3-45NS-CNR-P-C   SW3-45NS-CNR-BL-P-C	4,5	3	6	295	*295	1375	70	45	separate	100	1900
SW3-60NS-CNR-P-C   SW3-60NS-CNR-BL-P-C	6,0	5	8	295	*295	1375	70	45	separate	100	1900
SW6-90NS-CNR-P-C   SW6-90NS-CNR-BL-P-C	9,0	8	15	410	*410	1375	160	80	separate	100	1900
SW6-120NS-CNR-P   SW6-120NS-CNR-BL-P	12,0	11	18	410	*410	1375	160	80	separate	100	2100



SAWO30 Corner (NB)



SAWO30 Corner Black (NB)

Built-in Control

HEATER MODEL	kW	SAUNA ROOM		SIZE OF HEATER			STONES		CONTROL	MINIMUM SAFETY DISTANCES	
		MIN (m³)	MAX	WIDTH	DEPTH	HEIGHT	Without Stone Spacer (kg)	With Stone Spacer		A	B
SW3-45NB-CNR-P-C   SW3-45NB-CNR-BL-P-C	4,5	3	6	295	*295	1375	70	45	built-in	100	1900
SW3-60NB-CNR-P-C   SW3-60NB-CNR-BL-P-C	6,0	5	8	295	*295	1375	70	45	built-in	100	1900
SW6-90NB-CNR-P-C   SW6-90NB-CNR-BL-P-C	9,0	8	15	410	*410	1375	160	80	built-in	100	1900

\*Depth when installed to the wall.

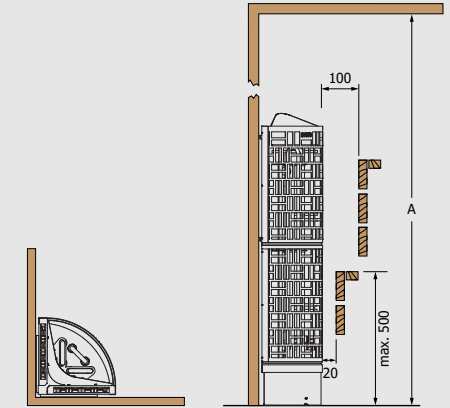

Minimum Safety Distances

Heater Accessories (Optional)

Integration Collars for Corner



Stainless



Wooden Cedar (D) & Aspen (A)



Soapstone

Heater Guards for Corner



Wooden Cedar (D) & Aspen (A)

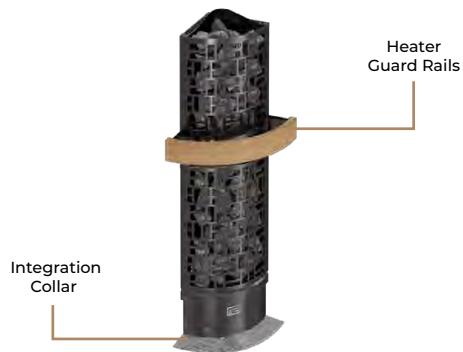

Heater Guard Rails

Integration Collar

MODEL	SIZE OF COLLAR		
	WIDTH (mm)	DEPTH (mm)	HEIGHT (mm)
TH-COLLAR-ST2-CNR	630	210	70
TH-COLLAR-ST4-CNR	675	210	65
TH-COLLAR-ST6-CNR	640	640	42

MODEL	SIZE OF COLLAR		
	WIDTH (mm)	DEPTH (mm)	HEIGHT (mm)
TH-COLLAR-W2-CNR-D   A	230	122	150
TH-COLLAR-W4-CNR-D   A	231	121	150
TH-COLLAR-W6-CNR-D   A	261	123	150

MODEL	SIZE OF COLLAR		
	WIDTH (mm)	DEPTH (mm)	HEIGHT (mm)
TH-COLLAR-S2-CNR	240	130	150
TH-COLLAR-S4-CNR	205	150	135
TH-COLLAR-S6-CNR	210	185	45

MODEL	SIZE OF GUARD RAIL	
	WIDTH (mm)	DEPTH (mm)
SW-GUARD-W2-CNR-D   A	580	420
SW-GUARD-W6-CNR-D   A	750	530

HEATERS
SW3
SW6
SW12

# TOWER Heaters

**Tower heaters** are developed to produce steam from the lowest to the highest part of the sauna, similar to smoke-sauna.

Tower heaters are equipped removable stone spacer, when in use you can enjoy more hotter temperature and save electricity through reduced heating time. The stone spacer improves air flow in the heater and helps to extend heating element life span when stones are not touching the elements.

When the stone spacer is not used, the large quantity of stones stores heat, releasing it steadily. The *löyly* is milder and softer.

Choose from Round, Wall or Corner model depending on your sauna layout.

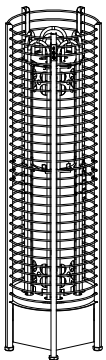

Round

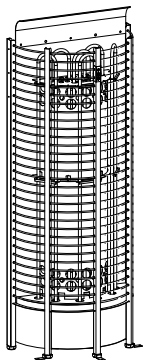

Wall

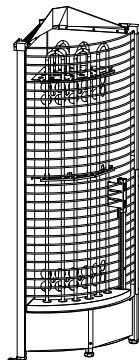

Corner





## Tower ROUND

- » Power Range: 3.0 – 24.0kW
- » Available controlling Ni2, Ni, NS and NB
- » Sauna Experience: Mild smooth heat, Humid
- » Stainless steel casing
- » Moving steel rings for replacement of broken stones
- » Removable stone spacer, choose between faster heating time and hotter heat or slower, milder heat.
- » Adjustable legs
- » Optional Heater Guard and Integration Collar



## Tower WALL

- » Power Range: 3.0 – 24.0kW
- » Available controlling Ni2, Ni, NS and NB
- » Sauna Experience: Mild smooth heat, Humid
- » Stainless steel casing
- » Moving rings for replacement of broken stones
- » Removable stone spacer, choose between faster heating time and hotter heat or slower, milder heat.
- » Adjustable legs
- » Optional Heater Guard and Integration Collar



## Tower CORNER

- » Power Range: 3.0 – 12.0kW
- » Available controlling Ni2, Ni, NS and NB
- » Sauna Experience: Mild smooth heat, Humid
- » Stainless steel casing
- » Moving upper part for replacement of broken stones
- » Removable stone spacer, choose between faster heating time and hotter heat or slower, milder heat.
- » Adjustable legs
- » Optional Heater Guard and Integration Collar



# TOWER Round

**Tower Round** is a timelessly elegant heater that will release long-lasting mild, steady and humid heat.

Round model is perfect to be placed in the middle of the sauna or embedded into benches. Suitable for small to extra-large saunas (2m<sup>3</sup> - 40m<sup>3</sup>).







Tower Round (Ni2)

Tower Round (Ni)

Ni2 & Ni

HEATER MODEL	kW	SAUNA ROOM		SIZE OF HEATER			STONES		CONTROL	MINIMUM SAFETY DISTANCES	
		MIN	MAX	WIDTH	DEPTH	HEIGHT	Without Stone Spacer	With Stone Spacer		A	B
TH2-30Ni2	3,0	2	4	260	260	1300	70	60	Saunova 2.0	100	1900
TH3-35Ni2	3,5	3	6	260	260	1300	70	60	Saunova 2.0	100	1900
TH3-45Ni2	4,5	3	6	260	260	1300	70	60	Saunova 2.0	100	1900
TH3-60Ni2	6,0	5	8	260	260	1300	70	60	Saunova 2.0	150	1900
TH4-60Ni2	6,0	5	9	315	315	1300	105	90	Saunova 2.0	150	1900
TH5-80Ni2	8,0	8	14	315	315	1300	105	90	Saunova 2.0	150	1900
TH5-90Ni2	9,0	8	14	315	315	1300	105	90	Saunova 2.0	150	1900
TH6-80Ni2	8,0	7	14	365	365	1300	160	100	Saunova 2.0	150	1900
TH6-90Ni2	9,0	8	15	365	365	1300	160	100	Saunova 2.0	150	1900
TH6-105Ni2	10,5	9	16	365	365	1300	160	100	Innova	150	1900
TH6-120Ni2	12,0	11	18	365	365	1300	160	100	Innova	200	2100
TH9-105Ni2	10,5	10	16	450	450	1300	230	165	Innova	150	2100
TH9-120Ni2	12,0	11	20	450	450	1300	230	165	Innova	150	2100
TH9-150Ni2	15,0	14	25	450	450	1300	230	165	Innova	200	2100
TH9-180Ni2	18,0	18	28	450	450	1300	230	165	Innova	200	2100
TH12-150Ni2	15,0	15	26	545	545	1300	360	220	Innova	200	2300
TH12-180Ni2	18,0	18	30	545	545	1300	360	220	Innova	200	2300
TH12-210Ni2	21,0	22	35	545	545	1300	360	220	Innova	200	2300
TH12-240Ni2	24,0	24	40	545	545	1300	360	220	Innova	200	2300



Tower Round (NB)

Tower Round (NS)

Built-in Control / Separate Control

HEATER MODEL	kW	SAUNA ROOM		SIZE OF HEATER			STONES		CONTROL	MINIMUM SAFETY DISTANCES	
		MIN	MAX	WIDTH	DEPTH	HEIGHT	Without Stone Spacer	With Stone Spacer		A	B
TH2-30NB   NS	3,0	2	4	260	260	1300	70	60	built-in separate	150 150	1900
TH3-35NB   NS	3,5	3	6	260	260	1300	70	60	built-in separate	150 100	1900
TH3-45NB   NS	4,5	3	6	260	260	1300	70	60	built-in separate	150 100	1900
TH3-60NB   NS	6,0	5	8	260	260	1300	70	60	built-in separate	150 150	1900
TH4-60NB   NS	6,0	5	9	315	315	1300	105	90	built-in separate	150 150	1900
TH5-80NB   NS	8,0	7	13	315	315	1300	105	90	built-in separate	100 100	1900
TH5-90NB   NS	9,0	8	14	315	315	1300	105	90	separate	150	1900
TH6-80NB   NS	8,0	7	14	365	365	1300	160	100	built-in separate	100 100	1900
TH6-90NB   NS	9,0	8	15	365	365	1300	160	100	built-in separate	100 100	1900
TH6-105NB   NS	10,5	9	16	365	365	1300	160	100	separate	150	1900
TH6-120NB   NS	12,0	11	18	365	365	1300	160	100	separate	200	2100
TH9-105NB   NS	10,5	10	16	450	450	1300	230	165	separate	150	2100
TH9-120NB   NS	12,0	11	20	450	450	1300	230	165	separate	150	2100
TH9-150NB   NS	15,0	14	25	450	450	1300	230	165	separate	200	2100
TH9-180NB   NS	18,0	18	28	450	450	1300	230	165	separate	200	2100
TH12-150NB   NS	15,0	15	26	545	545	1300	360	220	separate	200	2300
TH12-180NB   NS	18,0	18	30	545	545	1300	360	220	separate	200	2300
TH12-210NB   NS	21,0	22	35	545	545	1300	360	220	separate	200	2300
TH12-240NB   NS	24,0	24	40	545	545	1300	360	220	separate	200	2300

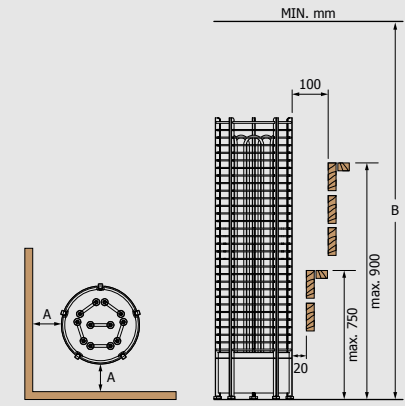

Minimum Safety Distances

Heater Accessories (Optional)

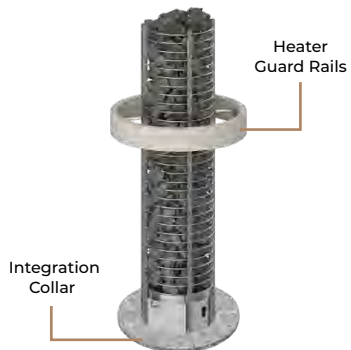

Stainless (for TH4 & TH5)



Stainless



Wooden Cedar (D) & Aspen (A)



Soapstone

MODEL	SIZE OF COLLAR
	WIDTH DEPTH HEIGHT (mm)
TH-COLLAR-V2-ST4	440 440 120

MODEL	SIZE OF COLLAR
	WIDTH DEPTH HEIGHT (mm)
TH-COLLAR-ST2	470 470 70
TH-COLLAR-ST4	545 545 55
TH-COLLAR-ST6	665 665 60
TH-COLLAR-ST9	720 720 42
TH-COLLAR-ST12	830 830 70

MODEL	SIZE OF COLLAR
	WIDTH DEPTH HEIGHT (mm)
TH-COLLAR-W2-D   A	449 187 150
TH-COLLAR-W4-D   A	495 200 150
TH-COLLAR-W6-D   A	547 215 150
TH-COLLAR-W9-D   A	608 233 150
TH-COLLAR-W12-D   A	694 258 150

MODEL	SIZE OF COLLAR
	WIDTH DEPTH HEIGHT (mm)
TH-COLLAR-S2	507 507 45
TH-COLLAR-S4	560 560 45
TH-COLLAR-S6	620 620 45
TH-COLLAR-S9	690 690 45
TH-COLLAR-S12	790 790 45

Heater Guards for Round



Wooden Cedar (D) & Aspen (A)

MODEL	SIZE OF GUARD RAIL
	WIDTH DEPTH HEIGHT (mm)
TH-GUARD-W2-D   A	510 270 210
TH-GUARD-W4-D   A	570 290 200
TH-GUARD-W6-D   A	625 625 110
TH-GUARD-W9-D   A	710 375 208
TH-GUARD-W12-D   A	810 420 220

MODEL
TH2   TH3
TH4   TH5
TH6
TH9
TH12

# TOWER Wall

**Tower Wall** is a timelessly elegant heater that will release long-lasting mild, steady and humid heat.

Wall model will save space on the layout, with still being a show-stopper of the sauna. Suitable for small to extra-large saunas (2m<sup>3</sup> - 40m<sup>3</sup>), to increase capacity to over 24kW you can always combine 2 Tower Walls back-to-back, which enables to grow power capacity as much as until 48kW.





Tower Wall (Ni2)

Tower Wall (Ni)

Ni2 & Ni

HEATER MODEL	KW	SAUNA ROOM (m³)		SIZE OF HEATER (mm)			STONES		CONTROL	MINIMUM SAFETY DISTANCES	
		MIN	MAX	WIDTH	DEPTH	HEIGHT	Without Stone Spacer (KG)	With Stone Spacer		A	B
TH2-30Ni2-WL	3,0	2	4	385	*230	1395	80	60	Saunova 2.0	100	1900
TH3-35Ni2-WL	3,5	3	6	385	*230	1395	80	60	Saunova 2.0	100	1900
TH3-45Ni2-WL	4,5	3	6	385	*230	1395	80	60	Saunova 2.0	100	1900
TH3-60Ni2-WL	6,0	5	8	385	*230	1395	80	60	Saunova 2.0	100	1900
TH4-60Ni2-WL	6,0	5	9	475	*250	1395	120	90	Saunova 2.0	100	1900
TH5-80Ni2-WL	8,0	8	14	475	*250	1395	120	90	Saunova 2.0	100	1900
TH5-90Ni2-WL	9,0	8	14	475	*250	1395	120	90	Saunova 2.0	100	1900
TH6-80Ni2-WL	8,0	7	14	550	*320	1395	160	105	Saunova 2.0	100	1900
TH6-90Ni2-WL	9,0	8	15	550	*320	1395	160	105	Saunova 2.0	100	1900
TH6-105Ni-WL	10,5	9	16	550	*320	1395	160	105	Innova	100	1900
TH6-120Ni-WL	12,0	11	18	550	*320	1395	160	105	Innova	100	2100
TH9-105Ni-WL	10,5	10	16	650	*355	1395	180	115	Innova	100	2100
TH9-120Ni-WL	12,0	11	20	650	*355	1395	180	115	Innova	100	2100
TH9-150Ni-WL	15,0	14	25	650	*355	1395	180	115	Innova	100	2100
TH12-150Ni-WL	15,0	15	26	790	*425	1395	250	165	Innova	100	2300
TH12-180Ni-WL	18,0	18	30	790	*425	1395	250	165	Innova	100	2300
TH12-210Ni-WL	21,0	22	35	790	*425	1395	250	165	Innova	100	2300
TH12-240Ni-WL	24,0	24	40	790	*425	1395	250	165	Innova	100	2300



Tower Wall (NB)

Tower Wall (NS)

Built-in Control / Separate Control

HEATER MODEL	KW	SAUNA ROOM (m³)		SIZE OF HEATER (mm)			STONES		CONTROL	MINIMUM SAFETY DISTANCES	
		MIN	MAX	WIDTH	DEPTH	HEIGHT	Without Stone Spacer (KG)	With Stone Spacer		A	B
TH2-30 NB NS-WL	3,0	2	4	385	*230	1395	80	60	built-in separate	100	1900
TH3-35 NB NS-WL	3,5	3	6	385	*230	1395	80	60	built-in separate	100	1900
TH3-45 NB NS-WL	4,5	3	6	385	*230	1395	80	60	built-in separate	100	1900
TH3-60 NB NS-WL	6,0	5	8	385	*230	1395	80	60	built-in separate	100	1900
TH4-60 NB NS-WL	6,0	5	9	475	*250	1395	120	90	built-in separate	100	1900
TH5-80 NB NS-WL	8,0	7	13	475	*250	1395	120	90	built-in separate	100	1900
TH5-90NS-WL	9,0	8	14	475	*250	1395	120	90	separate	100	1900
TH6-80 NB NS-WL	8,0	7	14	550	*320	1395	160	105	built-in separate	100	1900
TH6-90 NB NS-WL	9,0	8	15	550	*320	1395	160	105	built-in separate	100	1900
TH6-105NS-WL	10,5	9	16	550	*320	1395	160	105	separate	100	2100
TH6-120NS-WL	12,0	11	18	550	*320	1395	160	105	separate	100	2100
TH9-105NS-WL	10,5	10	16	650	*355	1395	180	115	separate	100	2100
TH9-120NS-WL	12,0	11	20	650	*355	1395	180	115	separate	100	2100
TH9-150NS-WL	15,0	14	25	650	*355	1395	180	115	separate	100	2100
TH9-180NS-WL	18,0	18	28	650	*355	1395	180	115	separate	100	2300
TH12-150NS-WL	15,0	15	26	790	*425	1395	250	165	separate	100	2300
TH12-180NS-WL	18,0	18	30	790	*425	1395	250	165	separate	100	2300
TH12-210NS-WL	21,0	22	35	790	*425	1395	250	165	separate	100	2300
TH12-240NS-WL	24,0	24	40	790	*425	1395	250	165	separate	100	2300

\*Depth when installed to the wall.

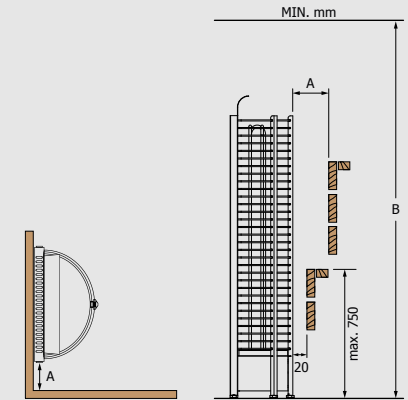

Minimum Safety Distances

Heater Accessories (Optional)

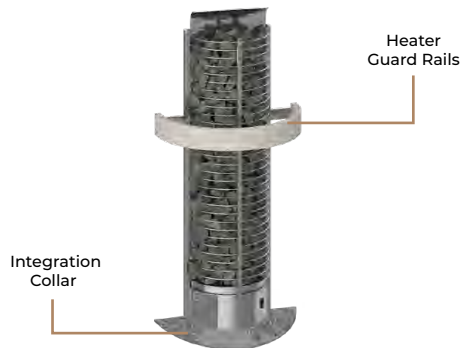

Integration Collars for Wall



MODEL	SIZE OF COLLAR (mm)		
	WIDTH	DEPTH	HEIGHT
TH-COLLAR-ST2-WL	665	365	70
TH-COLLAR-ST4-WL	730	395	55
TH-COLLAR-ST6-WL	640	640	42
TH-COLLAR-ST9-WL	895	483	70
TH-COLLAR-ST12-WL	1020	543	70

MODEL	SIZE OF COLLAR (mm)		
	WIDTH	DEPTH	HEIGHT
TH-COLLAR-W2-WL-D   A	342	144	150
TH-COLLAR-W4-WL-D   A	384	149	150
TH-COLLAR-W6-WL-D   A	422	155	150
TH-COLLAR-W9-WL-D   A	471	161	150
TH-COLLAR-W12-WL-D   A	540	170	150

MODEL	SIZE OF COLLAR (mm)		
	WIDTH	DEPTH	HEIGHT
TH-COLLAR-S2-WL	270	150	140
TH-COLLAR-S4-WL	342	185	125
TH-COLLAR-S6-WL	280	195	45
TH-COLLAR-S9-WL	285	225	45
TH-COLLAR-S12-WL	416	238	138

Heater Guards for Wall



MODEL	SIZE OF GUARD RAIL (mm)		
	WIDTH	DEPTH	HEIGHT
TH-GUARD-W2-WL-D   A	645	355	95
TH-GUARD-W4-WL-D   A	721	391	90
TH-GUARD-W6-WL-D   A	810	444	110
TH-GUARD-W9-WL-D   A	904	476	110
TH-GUARD-W12-WL-D   A	810	420	220

MODEL
TH2   TH3
TH4   TH5
TH6
TH9
TH12

# TOWER Corner

**Tower Corner** is designed to fit into tight corners, this model maximizes your sauna layout without sacrificing style.

The Tower Corner will ensure a gentle, soothing warmth for a truly relaxing experience.

Suitable for small to large saunas (2m<sup>3</sup> - 18m<sup>3</sup>).





Tower Round (Ni2)

Tower Round (Ni)



Tower Round (NB)

Tower Round (NS)

Ni2 & Ni

HEATER MODEL	KW	SAUNA ROOM (m²)		SIZE OF HEATER (mm)			STONES (kg)		CONTROL	MINIMUM SAFETY DISTANCES (mm)	
		MIN	MAX	WIDTH	DEPTH	HEIGHT	Without Stone Spacer	With Stone Spacer		A	B
TH2-30Ni2-CNR	3,0	2	4	300	*300	1380	70	45	Saunova	100	1900
TH3-35Ni2-CNR	3,5	3	6	300	*300	1380	70	45	Saunova	100	1900
TH3-45Ni2-CNR	4,5	3	6	300	*300	1380	70	45	Saunova	100	1900
TH3-60Ni2-CNR	6,0	5	8	300	*300	1380	70	45	Saunova	100	1900
TH4-60Ni2-CNR	6,0	5	9	355	*355	1380	105	70	Saunova	100	1900
TH5-80Ni2-CNR	8,0	7	13	355	*355	1380	105	70	Saunova	100	1900
TH5-90Ni2-CNR	9,0	8	14	355	*355	1380	105	70	Saunova	100	1900
TH6-80Ni2-CNR	8,0	7	14	415	*415	1380	160	80	Saunova	100	1900
TH6-90Ni2-CNR	9,0	8	15	415	*415	1380	160	80	Saunova	100	1900
TH6-105Ni2-CNR	10,5	9	16	415	*415	1380	160	80	Built-in Innova	100	1900
TH6-120Ni2-CNR	12,0	11	18	415	*415	1380	160	80	Built-in Innova	100	2100

Built-in Control

HEATER MODEL	KW	SAUNA ROOM (m²)		SIZE OF HEATER (mm)			STONES (kg)		CONTROL	MINIMUM SAFETY DISTANCES (mm)	
		MIN	MAX	WIDTH	DEPTH	HEIGHT	Without Stone Spacer	With Stone Spacer		A	B
TH2-30NB-CNR	3,0	2	4	300	*300	1380	70	45	built-in	125	1900
TH3-35NB-CNR	3,5	3	6	300	*300	1380	70	45	built-in	125	1900
TH3-45NB-CNR	4,5	3	6	300	*300	1380	70	45	built-in	125	1900
TH3-60NB-CNR	6,0	5	8	300	*300	1380	70	45	built-in	125	1900
TH4-60NB-CNR	6,0	5	9	355	*355	1380	105	70	built-in	125	1900
TH5-80NB-CNR	8,0	7	13	355	*355	1380	105	70	built-in	125	1900
TH6-80NB-CNR	8,0	7	14	415	*415	1380	160	80	built-in	125	1900
TH6-90NB-CNR	9,0	8	15	415	*415	1380	160	80	built-in	125	1900

Separate Control

HEATER MODEL	KW	SAUNA ROOM (m²)		SIZE OF HEATER (mm)			STONES (kg)		CONTROL	MINIMUM SAFETY DISTANCES (mm)	
		MIN	MAX	WIDTH	DEPTH	HEIGHT	Without Stone Spacer	With Stone Spacer		A	B
TH2-30NS-CNR	3,0	2	4	300	*300	1380	70	45	separate	100	1900
TH3-35NS-CNR	3,5	3	6	300	*300	1380	70	45	separate	100	1900
TH3-45NS-CNR	4,5	3	6	300	*300	1380	70	45	separate	100	1900
TH3-60NS-CNR	6,0	5	8	300	*300	1380	70	45	separate	100	1900
TH4-60NS-CNR	6,0	5	9	355	*355	1380	105	70	separate	100	1900
TH5-80NS-CNR	8,0	7	13	355	*355	1380	105	70	separate	100	1900
TH5-90NS-CNR	9,0	8	14	355	*355	1380	105	70	separate	100	1900
TH6-80NS-CNR	8,0	7	14	415	*415	1380	160	80	separate	100	1900
TH6-90NS-CNR	9,0	8	15	415	*415	1380	160	80	separate	100	1900
TH6-105NS-CNR	10,5	9	16	415	*415	1380	160	80	separate	100	1900
TH6-120NS-CNR	12,0	11	18	415	*415	1380	160	80	separate	100	2100

\*Depth when installed to the wall.

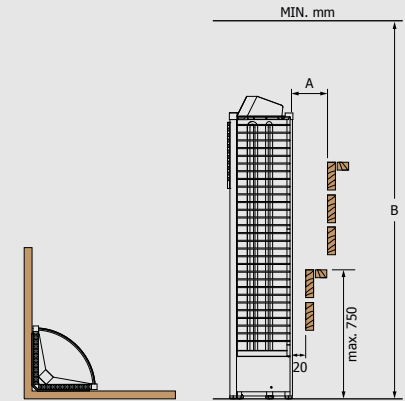

Minimum Safety Distances

Heater Accessories (Optional)

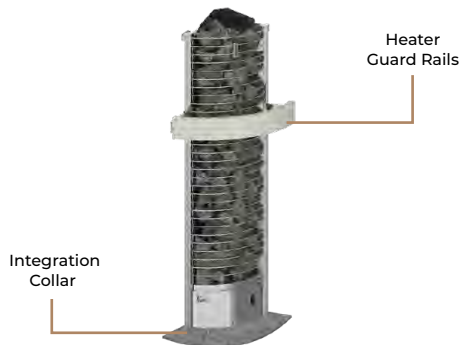

Integration Collars for Corner



Stainless



Wooden Cedar (D) & Aspen (A)



Soapstone

MODEL	SIZE OF COLLAR (mm)		
	WIDTH	DEPTH	HEIGHT
TH-COLLAR-ST2-CNR	630	210	70
TH-COLLAR-ST4-CNR	675	210	65
TH-COLLAR-ST6-CNR	640	640	42

MODEL	SIZE OF COLLAR (mm)		
	WIDTH	DEPTH	HEIGHT
TH-COLLAR-W2-CNR-D   A	230	122	150
TH-COLLAR-W4-CNR-D   A	231	121	150
TH-COLLAR-W6-CNR-D   A	261	123	150

MODEL	SIZE OF COLLAR (mm)		
	WIDTH	DEPTH	HEIGHT
TH-COLLAR-S2-CNR	240	130	150
TH-COLLAR-S4-CNR	205	150	135
TH-COLLAR-S6-CNR	210	185	45

Heater Guards for Corner



Wooden Cedar (D) & Aspen (A)

MODEL	SIZE OF GUARD RAIL (mm)		
	WIDTH	DEPTH	HEIGHT
TH-GUARD-W2-CNR-D A	595	237	90
TH-GUARD-W4-CNR-D A	670	252	90
TH-GUARD-W6-CNR-D A	755	200	120

MODEL
TH2   TH3
TH4   TH5
TH6

# ARIES Heaters

**Aries heaters** are for those who appreciate simple structure and modern design. Choose from Round, Wall or Corner model depending on your sauna layout. Best for small and medium-sized saunas (3m<sup>3</sup> - 29m<sup>3</sup>).

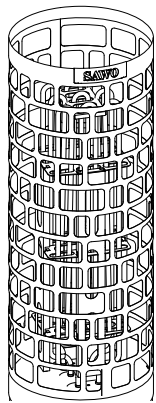

Round

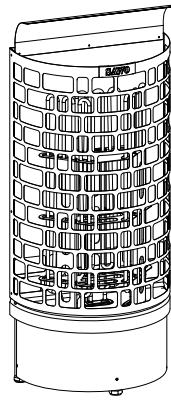

Wall

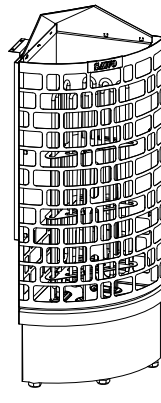

Corner





## Aries ROUND

- » Power range 4.5 - 18.0kW
- » Available controlling Ni2, NS, NB
- » Sauna Experience: Medium heat, Humid
- » Built-in stone spacer
- » Stainless or black steel casing
- » Adjustable legs
- » Optional Heater guard and integration collar



## Aries WALL

- » Power range 4.5 - 9.0kW
- » Available controlling Ni2, NS, NB
- » Sauna Experience: Medium heat, Humid
- » Built-in stone spacer
- » Stainless or black steel casing
- » Adjustable legs
- » Optional Heater guard and integration collar



## Aries CORNER

- » Power range 4.5 - 9.0kW
- » Available controlling Ni2, NS, NB
- » Sauna Experience: Medium heat, Humid
- » Built-in stone spacer
- » Stainless or black steel casing
- » Adjustable legs
- » Optional Heater guard and integration collar

# ARIES Round

**Aries Round** is a uniquely designed sauna heater that delivers consistent, medium heat. The stylish round shape makes it perfect for placement in the center of the sauna or embedded into benches.

Aries Round heater is a versatile option for saunas of all sizes, from small to large (3m<sup>3</sup> - 29m<sup>3</sup>).





## Technical DATA



Aries Round (Ni2)



Aries Round Black (Ni2)

### Ni2

HEATER MODEL	KW	SAUNA ROOM		SIZE OF HEATER			STONES (KG)	MINIMUM SAFETY DISTANCES	
		MIN (m²)	MAX	WIDTH	DEPTH (mm)	HEIGHT		A	B
ARI3-45Ni2   ARI3-45Ni2-BL	4,5	3	6	300	300	930	60	100	1900
ARI3-60Ni2   ARI3-60Ni2-BL	6,0	5	8	300	300	930	60	100	1900
ARI3-75Ni2   ARI3-75Ni2-BL	7,5	7	12	300	300	930	60	100	1900
ARI3-90Ni2   ARI3-90Ni2-BL	9,0	8	14	300	300	930	60	100	1900



Aries Round (NS)



Aries Round Black (NS)

### Separate Control

HEATER MODEL	KW	SAUNA ROOM		SIZE OF HEATER			STONES (KG)	MINIMUM SAFETY DISTANCES	
		MIN (m²)	MAX	WIDTH	DEPTH (mm)	HEIGHT		A	B
ARI3-45NS   ARI3-45NS-BL	4,5	3	6	300	300	930	60	100	1900
ARI3-60NS   ARI3-60NS-BL	6,0	5	8	300	300	930	60	100	1900
ARI3-75NS   ARI3-75NS-BL	7,5	7	12	300	300	930	60	100	1900
ARI3-90NS   ARI3-90NS-BL	9,0	8	14	300	300	930	60	100	1900
ARI6-90NS   ARI6-90NS-BL	9,0	8	15	440	440	930	110	100	1900
ARI6-105NS   ARI6-105NS-BL	10,5	9	16	440	440	930	110	100	1900
ARI6-120NS   ARI6-120NS-BL	12,0	10	18	440	440	930	110	100	2100
ARI6-150NS   ARI6-150NS-BL	15,0	13	24	440	440	930	110	100	2100
ARI6-180NS   ARI6-180NS-BL	18,0	18	30	440	440	930	110	125	2100



Aries Round (NB)



Aries Round Black (NB)

### Built-in Control

HEATER MODEL	KW	SAUNA ROOM		SIZE OF HEATER			STONES (KG)	MINIMUM SAFETY DISTANCES	
		MIN (m²)	MAX	WIDTH	DEPTH (mm)	HEIGHT		A	B
ARI3-45NB   ARI3-45NB-BL	4,5	3	6	300	300	930	60	100	1900
ARI3-60NB   ARI3-60NB-BL	6,0	5	8	300	300	930	60	100	1900
ARI3-75NB   ARI3-75NB-BL	7,5	7	12	300	300	930	60	100	1900
ARI3-90NB   ARI3-90NB-BL	9,0	8	14	300	300	930	60	100	1900
ARI6-90NB   ARI6-90NB-BL	9,0	8	15	440	440	930	110	100	1900

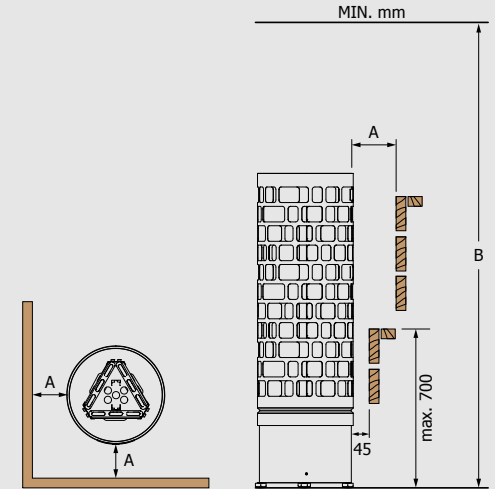

Minimum Safety Distances

### Heater Accessories (Optional)

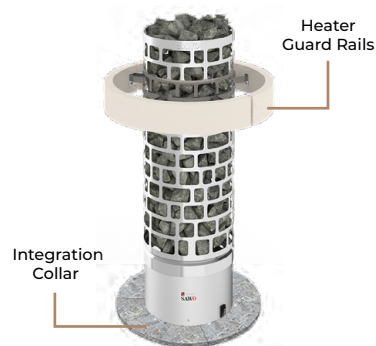

Stainless (for ARI3)

MODEL	SIZE OF COLLAR		
	WIDTH	DEPTH	HEIGHT
TH-COLLAR-V2-ST4	440	440	120



Stainless

MODEL	SIZE OF COLLAR		
	WIDTH	DEPTH	HEIGHT
TH-COLLAR-ST4	545	545	55
TH-COLLAR-ST6	665	665	60



Wooden Cedar (D) & Aspen (A)

MODEL	SIZE OF COLLAR		
	WIDTH	DEPTH	HEIGHT
TH-COLLAR-W4-D   A	495	200	150
TH-COLLAR-W6-D   A	547	215	150



Soapstone

MODEL	SIZE OF COLLAR		
	WIDTH	DEPTH	HEIGHT
TH-COLLAR-S4	560	560	45
TH-COLLAR-S6	620	620	45



Wooden Cedar (D) & Aspen (A)

MODEL	SIZE OF GUARD RAIL		
	WIDTH	DEPTH	HEIGHT
ARI-GUARD-W3-D   A	585	570	120
ARI-GUARD-W6-D   A	710	700	110

MODEL
ARI3
ARI6

# ARIES Wall

**Aries Wall** is a space-saving, uniquely designed sauna heater that delivers consistent, medium heat. Its sleek design is perfect for installation next to the wall, freeing up valuable space in your sauna.

Ideal for small to medium-sized saunas (3m<sup>3</sup> - 14m<sup>3</sup>), Aries Wall heater combines practicality with elegance.





Aries Wall (Ni2)

Aries Wall Black (Ni2)

Ni2

HEATER MODEL	kW	SAUNA ROOM (m <sup>2</sup> )		SIZE OF HEATER (mm)			STONES (kg)	MINIMUM SAFETY DISTANCES	
		MIN	MAX	WIDTH	DEPTH	HEIGHT		A	B
ARI3-45Ni2-WL   ARI3-45Ni2-WL-BL	4,5	3	6	415	*250	1030	65	100	1900
ARI3-60Ni2-WL   ARI3-60Ni2-WL-BL	6,0	5	8	415	*250	1030	65	100	1900
ARI3-75Ni2-WL   ARI3-75Ni2-WL-BL	7,5	7	12	415	*250	1030	65	100	1900
ARI3-90Ni2-WL   ARI3-90Ni2-WL-BL	9,0	8	14	415	*250	1030	65	100	1900



Aries Wall (NS)

Aries Wall Black (NS)

Separate Control

HEATER MODEL	kW	SAUNA ROOM (m <sup>2</sup> )		SIZE OF HEATER (mm)			STONES (kg)	MINIMUM SAFETY DISTANCES	
		MIN	MAX	WIDTH	DEPTH	HEIGHT		A	B
ARI3-45NS-WL   ARI3-45NS-WL-BL	4,5	3	6	415	*250	1030	65	100	1900
ARI3-60NS-WL   ARI3-60NS-WL-BL	6,0	5	8	415	*250	1030	65	100	1900
ARI3-75NS-WL   ARI3-75NS-WL-BL	7,5	7	12	415	*250	1030	65	100	1900
ARI3-90NS-WL   ARI3-90NS-WL-BL	9,0	8	14	415	*250	1030	65	100	1900



Aries Wall (NB)

Aries Wall Black (NB)

Built-in Control

HEATER MODEL	kW	SAUNA ROOM (m <sup>2</sup> )		SIZE OF HEATER (mm)			STONES (kg)	MINIMUM SAFETY DISTANCES	
		MIN	MAX	WIDTH	DEPTH	HEIGHT		A	B
ARI3-45NB-WL   ARI3-45NB-WL-BL	4,5	3	6	415	*250	1030	65	100	1900
ARI3-60NB-WL   ARI3-60NB-WL-BL	6,0	5	8	415	*250	1030	65	100	1900
ARI3-75NB-WL   ARI3-75NB-WL-BL	7,5	7	12	415	*250	1030	65	100	1900
ARI3-90NB-WL   ARI3-90NB-WL-BL	9,0	8	14	415	*250	1030	65	100	1900

\*Depth when installed to the wall.

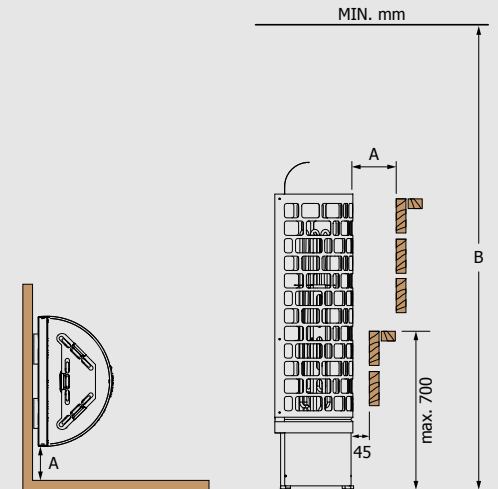

Minimum Safety Distances



Heater Accessories (Optional)

Integration Collars for Wall



Stainless



Wooden Cedar (D) & Aspen (A)



Soapstone

MODEL	SIZE OF COLLAR (mm)	WIDTH	DEPTH	HEIGHT
TH-COLLAR-ST4-WL	730	395	55	

MODEL	SIZE OF COLLAR (mm)	WIDTH	DEPTH	HEIGHT
TH-COLLAR-W4-WL-D   A	384	149	150	

MODEL	SIZE OF COLLAR (mm)	WIDTH	DEPTH	HEIGHT
TH-COLLAR-S4-WL	342	185	125	

Heater Guards for Wall

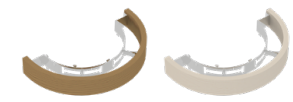

Wooden Cedar (D) & Aspen (A)

MODEL	SIZE OF GUARD RAIL (mm)	WIDTH	DEPTH	HEIGHT
ARI-GUARD-W3-WL-D   A	665	380	120	

MODEL
ARI3

# ARIES Corner

**Aries Corner** is a space-saving, uniquely designed sauna heater that delivers consistent, medium heat. Designed to fit snugly into the corner, this model maximizes your sauna layout without compromising style.

Ideal for small to medium-sized saunas (3m<sup>3</sup> - 14m<sup>3</sup>), perfect for saunas with limited space.





Aries Corner (Ni2)



Aries Corner Black (Ni2)

Ni2

HEATER MODEL	kW	SAUNA ROOM (m³)		SIZE OF HEATER (mm)			STONES (kg)	MINIMUM SAFETY DISTANCES	
		MIN	MAX	WIDTH	DEPTH	HEIGHT		A	B
ARI3-45Ni2-CNR   ARI3-45Ni2-CNR-BL	4,5	3	6	335	*335	1000	65	100	1900
ARI3-60Ni2-CNR   ARI3-60Ni2-CNR-BL	6,0	5	8	335	*335	1000	65	100	1900
ARI3-75Ni2-CNR   ARI3-75Ni2-CNR-BL	7,5	7	12	335	*335	1000	65	100	1900
ARI3-90Ni2-CNR   ARI3-90Ni2-CNR-BL	9,0	8	14	335	*335	1000	65	100	1900



Aries Corner (NS)



Aries Corner Black (NS)

Separate Control

HEATER MODEL	kW	SAUNA ROOM (m³)		SIZE OF HEATER (mm)			STONES (kg)	MINIMUM SAFETY DISTANCES	
		MIN	MAX	WIDTH	DEPTH	HEIGHT		A	B
ARI3-45NS-CNR   ARI3-45NS-CNR-BL	4,5	3	6	335	*335	1000	65	100	1900
ARI3-60NS-CNR   ARI3-60NS-CNR-BL	6,0	5	8	335	*335	1000	65	100	1900
ARI3-75NS-CNR   ARI3-75NS-CNR-BL	7,5	7	12	335	*335	1000	65	100	1900
ARI3-90NS-CNR   ARI3-90NS-CNR-BL	9,0	8	14	335	*335	1000	65	100	1900

Built-in Control

HEATER MODEL	kW	SAUNA ROOM (m³)		SIZE OF HEATER (mm)			STONES (kg)	MINIMUM SAFETY DISTANCES	
		MIN	MAX	WIDTH	DEPTH	HEIGHT		A	B
ARI3-45NB-CNR   ARI3-45NB-CNR-BL	4,5	3	6	335	*335	1000	65	100	1900
ARI3-60NB-CNR   ARI3-60NB-CNR-BL	6,0	5	8	335	*335	1000	65	100	1900
ARI3-75NB-CNR   ARI3-75NB-CNR-BL	7,5	7	12	335	*335	1000	65	100	1900
ARI3-90NB-CNR   ARI3-90NB-CNR-BL	9,0	8	14	335	*335	1000	65	100	1900

\*Depth when installed to the wall.



Aries Corner (NB)



Aries Corner Black (NB)

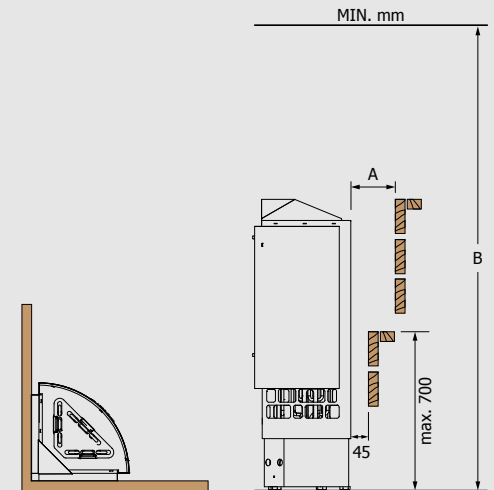

Minimum Safety Distances

Heater Accessories (Optional)

Integration Collars for Corner



Stainless



Wooden Cedar (D) & Aspen (A)



Soapstone

MODEL	SIZE OF COLLAR (mm)		
	WIDTH	DEPTH	HEIGHT
TH-COLLAR-ST4-CNR	675	210	65

MODEL	SIZE OF COLLAR (mm)		
	WIDTH	DEPTH	HEIGHT
TH-COLLAR-W4-CNR-D   A	231	121	150

MODEL	SIZE OF COLLAR (mm)		
	WIDTH	DEPTH	HEIGHT
TH-COLLAR-S4-CNR	205	150	135

Corner Heater Guards



Wooden Cedar (D) & Aspen (A)

MODEL	SIZE OF GUARD RAIL (mm)		
	WIDTH	DEPTH	HEIGHT
ARI-GUARD-W3-D   A	585	570	120

MODEL
ARI3



# CUBOS Heater

**Cubos** is 3-in-1 heater! It can be placed in the middle, corner or wall of the sauna room. Additional protective covers will add support for wall and corner installation. This modern and versatile heater is one of a kind.

**Cubos** is also available with Saunova 2.0 control (Ni2). Ni2 heaters are effortless to install, easy and energy-efficient to use. Perfect choice for modern saunas.

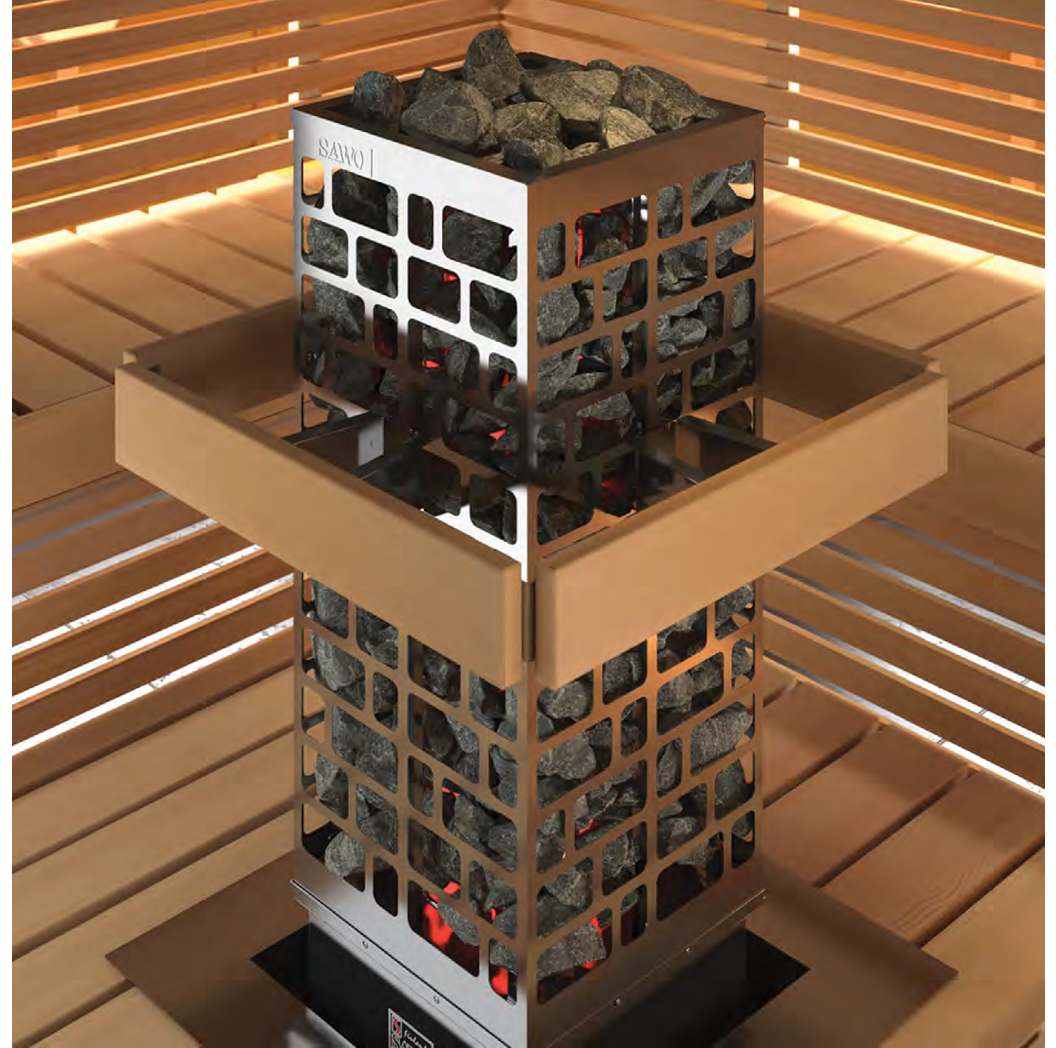

Saunova 2.0 Operated  
(Ni2)



Separate  
(NS)



Built-in Control  
(NB)

## Middle Installation

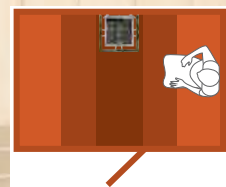
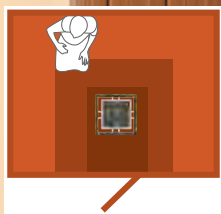

## Wall Installation with Protective Cover

Cubos is a versatile heater with 3 different installation options. By adding Cubos Protective Cover, the cubos heater can be transformed to Wall or Corner heater.

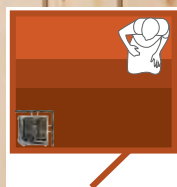

## Corner Installation with Protective Cover



## Cubos

- » Power range 4.5 - 9.0kW
- » Available controlling Ni2, NS, NB
- » Sauna Experience: Medium heat, Humid
- » Built-in stone spacer
- » Stainless steel casing
- » Adjustable legs
- » Optional Heater guard and integration collar



## Protective Cover Accessory

### Wall Installation

Use Cubos Protective Cover for wall installation. Best for sauna designs with limited space. The set of the protective cover for wall includes covering sheet and a reflector that directs heat even to lowest parts of the sauna room.

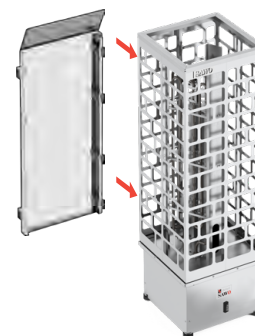

### Wall Installation with Protective Cover

MODEL	SIZE OF COVER		
	WIDTH	DEPTH	HEIGHT
CUB-PROCOV-WL	660	300	65

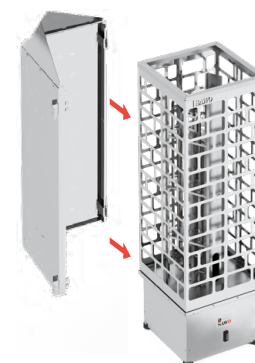

### Corner Installation with Protective Cover

### Corner Installation

Cubos quickly changes to corner model with Protective Cover for corner. Corner installation saves space and enables using different bench designs. The protective cover for corner set includes two pieces of covering sheet, a connection rod and a heat reflector.

MODEL	SIZE OF COVER		
	WIDTH	DEPTH	HEIGHT
CUB-PROCOV-CNR	660	300	100

# Technical DATA

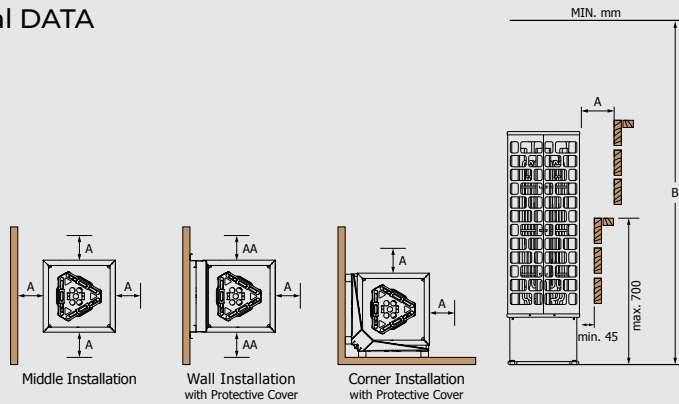

## Minimum Safety Distances



## Heater Accessories (Optional)

### Cubos Heater Collars

**Wooden Collar for CUB3 Middle Installation Cedar (D) & Aspen (A)**

MODEL	SIZE OF COLLAR (mm)		
	WIDTH	DEPTH	HEIGHT
CUB-COLLAR-W3-D	550	110	200
CUB-COLLAR-W3-A	550	110	200

**Wooden Collar for CUB3 Wall Installation Cedar (D) & Aspen (A)**

MODEL	SIZE OF COLLAR (mm)		
	WIDTH	DEPTH	HEIGHT
CUB-COLLAR-W3-WL-D	462	395	45
CUB-COLLAR-W3-WL-A	462	395	45

**Stainless Steel Collar for CUB3 Middle Installation**

MODEL	SIZE OF COLLAR (mm)		
	WIDTH	DEPTH	HEIGHT
CUB-COLLAR-ST3	545	70	550

**Stainless Steel Collar for CUB3 Wall Installation**

MODEL	SIZE OF COLLAR (mm)		
	WIDTH	DEPTH	HEIGHT
CUB-COLLAR-ST3-WL	545	70	490

**Soapstone Collar for CUB3 Middle Installation**

MODEL	SIZE OF COLLAR (mm)		
	WIDTH	DEPTH	HEIGHT
CUB-COLLAR-S3	550	200	110

**Soapstone Collar for CUB3 Wall Installation**

MODEL	SIZE OF COLLAR (mm)		
	WIDTH	DEPTH	HEIGHT
CUB-COLLAR-S3-WL	550	150	150

## Ni2

HEATER MODEL	kW	SAUNA ROOM		SIZE OF HEATER (mm)							STONES (KG)	CONTROL	MINIMUM SAFETY DISTANCES		
		MIN	MAX	MIDDLE		WALL		CORNER					A	AA	B
		(m³)	(m³)	WIDTH	DEPTH	WIDTH	DEPTH	WIDTH	DEPTH	HEIGHT					
CUB3-45Ni2	4,5	3	6	290	290	290	340	340	340	930	75	Saunova 2.0	100	100	1900
CUB3-60Ni2	6,0	5	9	290	290	290	340	340	340	930	75	Saunova 2.0	100	100	1900
CUB3-75Ni2	7,5	7	13	290	290	290	340	340	340	930	75	Saunova 2.0	100	135	1900
CUB3-90Ni2	9,0	8	14	290	290	290	340	340	340	930	75	Saunova 2.0	125	135	1900

## Separate Control

HEATER MODEL	kW	SAUNA ROOM		SIZE OF HEATER (mm)							STONES (KG)	CONTROL	MINIMUM SAFETY DISTANCES		
		MIN	MAX	MIDDLE		WALL		CORNER					A	AA	B
		(m³)	(m³)	WIDTH	DEPTH	WIDTH	DEPTH	WIDTH	DEPTH	HEIGHT					
CUB3-45NS	4,5	3	6	290	290	290	340	340	340	930	75	separate	100	100	1900
CUB3-60NS	6,0	5	9	290	290	290	340	340	340	930	75	separate	100	100	1900
CUB3-75NS	7,5	7	13	290	290	290	340	340	340	930	75	separate	100	135	1900
CUB3-90NS	9,0	8	14	290	290	290	340	340	340	930	75	separate	125	135	1900

## Built-in Control

HEATER MODEL	kW	SAUNA ROOM		SIZE OF HEATER (mm)							STONES (KG)	CONTROL	MINIMUM SAFETY DISTANCES		
		MIN	MAX	MIDDLE		WALL		CORNER					A	AA	B
		(m³)	(m³)	WIDTH	DEPTH	WIDTH	DEPTH	WIDTH	DEPTH	HEIGHT					
CUB3-45NB	4,5	3	6	290	290	290	340	340	340	930	75	built-in	100	100	1900
CUB3-60NB	6,0	5	9	290	290	290	340	340	340	930	75	built-in	100	100	1900
CUB3-75NB	7,5	7	13	290	290	290	340	340	340	930	75	built-in	100	135	1900
CUB3-90NB	9,0	8	14	290	290	290	340	340	340	930	75	built-in	125	135	1900

### Cubos Heater Guards

**Wooden Heater Guard for CUB3 Middle Installation Cedar (D) & Aspen (A)**

MODEL	SIZE OF GUARD RAIL (mm)		
	WIDTH	DEPTH	HEIGHT
CUB-GUARD-W3-D	530	150	170
CUB-GUARD-W3-A	530	150	170

**Wooden Heater Guard for CUB3 Wall Installation Cedar (D) & Aspen (A)**

MODEL	SIZE OF GUARD RAIL (mm)		
	WIDTH	DEPTH	HEIGHT
CUB-GUARD-W3-WL-D	550	150	150
CUB-GUARD-W3-WL-A	540	150	170

**Wooden Heater Guard for CUB3 Corner Installation Cedar (D) & Aspen (A)**

MODEL	SIZE OF GUARD RAIL (mm)		
	WIDTH	DEPTH	HEIGHT
CUB-GUARD-W3-CNR-D	458	150	150
CUB-GUARD-W3-CNR-A	458	150	170



# PHOENIX Heater

Rise from the ashes after a long day at work, and feel like a newborn with our **Phoenix heater**. The broadening shape, inspired by an Olympic torch, allows more stones to be placed in the top, ensuring creation of greater amount of pampering steam. Phoenix is suitable for small to large saunas (4.5m<sup>3</sup> - 18.0m<sup>3</sup>).

- » Stainless tubes hold the stones
- » Stone spacer inside to prolong heating elements lifespan
- » Floor standing
- » Can fit from 85kg to 130kg of stones
- » 4,5kW - 18,0kW power
- » Separate, Ni2 control
- » Adjustable legs
- » Optional integration collar



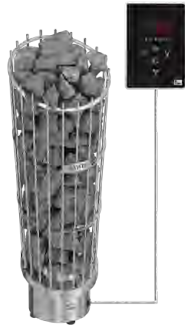

Phoenix (Ni2)



Phoenix (NS)

Ni2

HEATER MODEL	kW	SAUNA ROOM (m³)		SIZE OF HEATER			STONES (KG)	CONTROL	MINIMUM SAFETY DISTANCES	
		MIN	MAX	WIDTH	DEPTH	HEIGHT			A	B
PNX3-45Ni2	4,5	3	6	375	340	1100	85	Saunova	100	1900
PNX3-60Ni2	6,0	5	9	375	340	1100	85	Saunova	125	1900
PNX3-75Ni2	7,5	7	13	375	340	1100	85	Saunova	125	1900
PNX3-90Ni2	9,0	8	14	375	340	1100	85	Saunova	150	1900
PNX6-90Ni2	9,0	8	15	525	475	1175	130	Saunova	150	1900

Separate Control

HEATER MODEL	kW	SAUNA ROOM (m³)		SIZE OF HEATER			STONES (KG)	CONTROL	MINIMUM SAFETY DISTANCES	
		MIN	MAX	WIDTH	DEPTH	HEIGHT			A	B
PNX3-45NS	4,5	3	6	375	340	1100	85	separate	100	1900
PNX3-60NS	6,0	5	9	375	340	1100	85	separate	125	1900
PNX3-75NS	7,5	7	13	375	340	1100	85	separate	125	1900
PNX3-90NS	9,0	8	14	375	340	1100	85	separate	150	1900
PNX6-90NS	9,0	8	15	525	475	1175	130	separate	150	1900
PNX6-105NS	10,5	9	16	525	475	1175	130	separate	150	1900
PNX6-120NS	12,0	11	18	525	475	1175	130	separate	150	2100
PNX6-150NS	15,0	14	25	525	475	1175	130	separate	150	2100
PNX6-180NS	18,0	18	28	525	475 <td 1175	130	separate	175	2100	

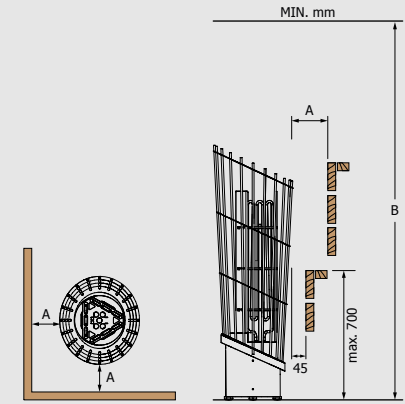

Minimum Safety Distances

Heater Accessories (Optional)



Stainless



Stainless Steel



Wooden  
Cedar (D) & Aspen (A)



Soapstone

MODEL	SIZE OF COLLAR (mm)		
	WIDTH	DEPTH	HEIGHT
TH-COLLAR-V2-ST4	440	440	120

MODEL	SIZE OF COLLAR (mm)		
	WIDTH	DEPTH	HEIGHT
TH-COLLAR-ST4	545	545	55
TH-COLLAR-ST9	720	720	42

MODEL	SIZE OF COLLAR (mm)		
	WIDTH	DEPTH	HEIGHT
TH-COLLAR-W4-D   A	495	200	150
TH-COLLAR-W9-D   A	608	233	150

MODEL	SIZE OF COLLAR (mm)		
	WIDTH	DEPTH	HEIGHT
TH-COLLAR-S4	560	560	45
TH-COLLAR-S9	690	690	45

MODEL
PNX3
PNX6





# Heaterking

**Heaterking heaters** by *Stefan Lindfors* give king size heat in a design cover. Its long impressive, shape holds massive amount of stones and provides heat for all kind of sauna bathers. You can enjoy either smooth or sharp and dry heat by throwing water either to the bottom or top of the pillar. Unique stainless steel Junglfire-pattern design holds the stone pillar with style. Choose from Round, Wall or Corner model depending on your sauna layout. Heaterking has suitable kW from small to large saunas (2m<sup>3</sup> - 40m<sup>3</sup>).



(Ni)



(NS)

## Heaterking ROUND (Ni, NS)

- » Power range 3,0 – 24,0kW
- » Control: Separate
- » Casing with intricate junglefire pattern
- » Stone spacer inside to prolong heating elements lifespan
- » Can fit from 60kg to 360kg of stones
- » Round-type stainless steel casing
- » Optional Heater guard



(NS)

## Heaterking WALL

- » Casing with intricate junglefire pattern
- » Stone spacer inside to prolong heating elements lifespan
- » Can fit from 60kg to 250kg of stones
- » 3,0kW - 24,0kW power
- » Wall type
- » Heat reflector included
- » Separate control



(NS)

## Heaterking CORNER

- » Power range 3,5 – 12,0kW
- » Control: Separate
- » Casing with intricate junglefire pattern
- » Stone spacer inside to prolong heating elements lifespan
- » Can fit from 45kg to 160kg of stones
- » Corner-type stainless steel casing
- » Heat reflector included
- » Optional Heater guard

# Technical DATA



Heaterking ROUND

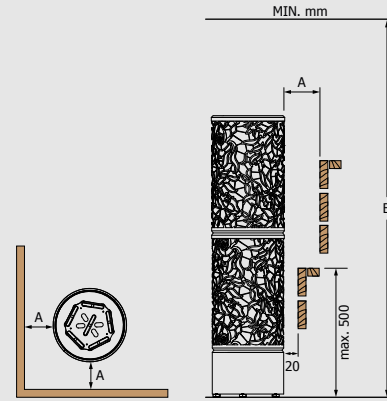

Minimum Safety Distances

## Ni Version

HEATER MODEL	kW	SAUNA ROOM (m³)		SIZE OF HEATER (mm)			STONES (kg)		CONTROL	MINIMUM SAFETY DISTANCES (mm)	
		MIN	MAX	WIDTH	DEPTH	HEIGHT	Without Stone Spacer	With Stone Spacer		A	B
DRFT6-80Ni	8,0	7	14	355	355	1325	160	100	Built-in Innova	100	1900
DRFT6-90Ni	9,0	8	15	355	355	1325	160	100	Built-in Innova	100	1900
DRFT6-105Ni	10,5	9	16	355	355	1325	160	100	Built-in Innova	150	1900
DRFT6-120Ni	12,0	11	18	355	355	1325	160	100	Built-in Innova	200	2100
DRFT9-105Ni	10,5	10	16	425	425	1325	230	165	Built-in Innova	150	1900
DRFT9-120Ni	12,0	11	20	425	425	1325	230	165	Built-in Innova	150	2100
DRFT9-150Ni	15,0	14	25	425	425	1325	230	165	Built-in Innova	200	2100
DRFT9-180Ni	18,0	18	28	425	425	1325	230	165	Built-in Innova	200	2300
DRFT12-150Ni	15,0	15	26	525	525	1325	360	220	Built-in Innova	200	2300
DRFT12-180Ni	18,0	18	30	525	525	1325	360	220	Built-in Innova	200	2300
DRFT12-210Ni	21,0	22	35	525	525	1325	360	220	Built-in Innova	200	2300
DRFT12-240Ni	24,0	24	40	525	525	1325	360	220	Built-in Innova	200	2300

## Separate Control

HEATER MODEL	kW	SAUNA ROOM (m³)		SIZE OF HEATER (mm)			STONES (kg)		CONTROL	MINIMUM SAFETY DISTANCES (mm)	
		MIN	MAX	WIDTH	DEPTH	HEIGHT	Without Stone Spacer	With Stone Spacer		A	B
DRFT2-30NS	3,0	2	4	250	250	1325	70	60	separate	150	1900
DRFT3-35NS	3,5	3	6	250	250	1325	70	60	separate	100	1900
DRFT3-45NS	4,5	3	6	250	250	1325	70	60	separate	100	1900
DRFT3-60NS	6,0	5	8	250	250	1325	70	60	separate	150	1900
DRFT4-60NS	6,0	5	9	295	295	1325	105	90	separate	100	1900
DRFT5-80NS	8,0	7	13	295	295	1325	105	90	separate	200	1900
DRFT5-90NS	9,0	8	14	295	295	1325	105	90	separate	200	1900
DRFT6-80NS	8,0	7	14	355	355	1325	160	100	separate	100	1900
DRFT6-90NS	9,0	8	15	355	355	1325	160	100	separate	100	1900
DRFT6-105NS	10,5	9	16	355	355	1325	160	100	separate	150	1900
DRFT6-120NS	12,0	11	18	355	355	1325	160	100	separate	200	2100
DRFT9-105NS	10,5	10	16	425	425	1325	230	165	separate	150	2100
DRFT9-120NS	12,0	11	20	425	425	1325	230	165	separate	150	2100
DRFT9-150NS	15,0	14	25	425	425	1325	230	165	separate	200	2100
DRFT9-180NS	18,0	18	28	425	425	1325	230	165	separate	200	2100
DRFT12-150NS	15,0	15	26	525	525	1325	360	220	separate	200	2300
DRFT12-180NS	18,0	18	30	525	525	1325	360	220	separate	200	2300
DRFT12-210NS	21,0	22	35	525	525	1325	360	220	separate	200	2300
DRFT12-240NS	24,0	24	40	525	525	1325	360	220	separate	200	2300

## Heater Accessories (Optional)

### Heaterking Round Heater Guards

Wooden Heater Guard for DRFT 2 & 3 H.E Round Cedar (D) & Aspen (A)



MODEL	SIZE OF GUARD RAIL (mm)		
	WIDTH	DEPTH	HEIGHT
DRFT-W2-D	517	264	200
DRFT-W2-A	517	264	200

Wooden Heater Guard for DRFT 4 & 5 H.E Round Cedar (D) & Aspen (A)



MODEL	SIZE OF GUARD RAIL (mm)		
	WIDTH	DEPTH	HEIGHT
DRFT-W4-D	570	290	200
DRFT-W4-A	570	290	200

Wooden Heater Guard for DRFT 6 H.E Round Cedar (D) & Aspen (A)



MODEL	SIZE OF GUARD RAIL (mm)		
	WIDTH	DEPTH	HEIGHT
DRFT-W6-D	595	304	120
DRFT-W6-A	595	304	120

Wooden Heater Guard for DRFT 9 H.E Round Cedar (D) & Aspen (A)



MODEL	SIZE OF GUARD RAIL (mm)		
	WIDTH	DEPTH	HEIGHT
DRFT-W9-D	700	365	200
DRFT-W9-A	700	365	200

Wooden Heater Guard for DRFT 12 H.E Round Cedar (D) & Aspen (A)



MODEL	SIZE OF GUARD RAIL (mm)		
	WIDTH	DEPTH	HEIGHT
DRFT-W12-D	800	411	200
DRFT-W12-A	800	411	200



# Technical DATA



Heaterking WALL

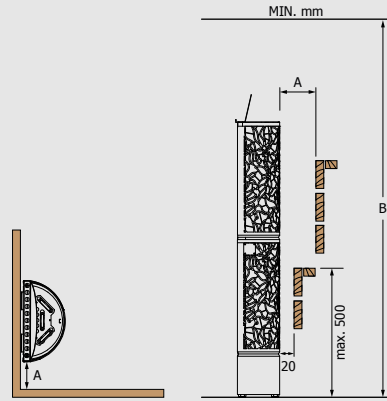

Minimum Safety Distances



Heaterking CORNER

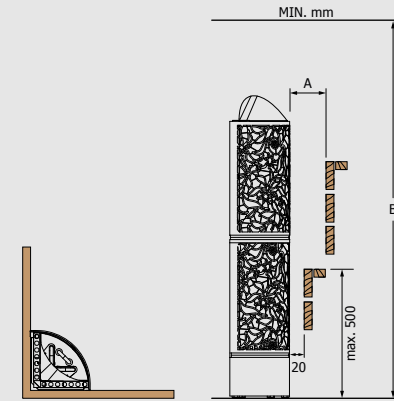

Minimum Safety Distances

## Separate Control

HEATER MODEL	kW	SAUNA ROOM		SIZE OF HEATER			STONES		CONTROL	MINIMUM SAFETY DISTANCES	
		MIN (m³)	MAX (m³)	WIDTH (mm)	DEPTH (mm)	HEIGHT (mm)	Without Stone Spacer (kg)	With Stone Spacer (kg)		A	B
DRFT3-35NS-WL	3,5	3	6	395	*220	1450	80	60	separate	100	1900
DRFT3-45NS-WL	4,5	3	6	395	*220	1450	80	60	separate	100	1900
DRFT3-60NS-WL	6,0	5	8	395	*220	1450	80	60	separate	100	1900
DRFT6-80NS-WL	8,0	7	14	545	*300	1465	160	105	separate	100	1900
DRFT6-90NS-WL	9,0	8	15	545	*300	1465	160	105	separate	100	1900
DRFT6-105NS-WL	10,5	9	16	545	*300	1465	160	105	separate	100	1900
DRFT6-120NS-WL	12,0	11	18	545	*300	1465	160	105	separate	100	2100
DRFT9-105NS-WL	10,5	10	16	650	*350	1510	180	115	separate	100	2100
DRFT9-120NS-WL	12,0	11	20	650	*350	1510	180	115	separate	100	2100
DRFT9-150NS-WL	15,0	14	25	650	*350	1510	180	115	separate	100	2100
DRFT9-180NS-WL	18,0	18	28	650	*350	1510	180	115	separate	100	2100
DRFT12-150NS-WL	15,0	15	26	790	*420	1555	250	165	separate	100	2300
DRFT12-180NS-WL	18,0	18	30	790	*420	1555	250	165	separate	100	2300
DRFT12-210NS-WL	21,0	22	35	790	*420	1555	250	165	separate	100	2300
DRFT12-240NS-WL	24,0	24	40	790	*420	1555	250	165	separate	100	2300

\*Depth when installed to the wall.

## Separate Control

HEATER MODEL	kW	SAUNA ROOM		SIZE OF HEATER			STONES		CONTROL	MINIMUM SAFETY DISTANCES	
		MIN (m³)	MAX (m³)	WIDTH (mm)	DEPTH (mm)	HEIGHT (mm)	Without Stone Spacer (kg)	With Stone Spacer (kg)		A	B
DRFT3-35NS-CNR	3,5	3	6	300	*300	1395	70	45	separate	100	1900
DRFT3-45NS-CNR	4,5	3	6	300	*300	1395	70	45	separate	100	1900
DRFT3-60NS-CNR	6,0	5	8	300	*300	1395	70	45	separate	100	1900
DRFT6-80NS-CNR	8,0	7	14	410	*410	1415	160	80	separate	100	1900
DRFT6-90NS-CNR	9,0	8	15	410	*410	1415	160	80	separate	100	1900
DRFT6-105NS-CNR	10,5	9	16	410	*410	1415	160	80	separate	100	1900
DRFT6-120NS-CNR	12,0	11	18	410	*410	1415	160	80	separate	100	2100

\*Depth when installed to the wall.



# Fiberjungle

A long shape of **Fiberjungle** holds great amount of stones giving pleasant heat - Junglefire heat. This heater is fully coated with black colored velvet cool-to-touch fiber, with pattern designed by Stefan Lindfors. It is not only a eye-catcher, but also a safe heater. Ideal for placing center of the sauna room, as the coating makes sure no one burns their skin.



(NS)

- » Power range 4.5 - 9.0kW
- » Available controlling NS
- » Sauna Experience: Mild smooth heat

## Technical DATA



Fiberjungle

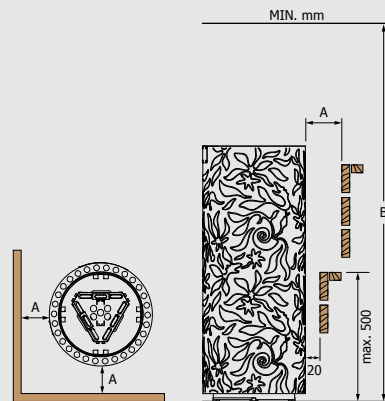

Minimum Safety Distances

## Separate Control

HEATER MODEL	kW	SAUNA ROOM		SIZE OF HEATER			STONES (KG)	CONTROL	MINIMUM SAFETY DISTANCES	
		MIN (m³)	MAX	WIDTH	DEPTH (mm)	HEIGHT			A	B
DRF3-45NS	4,5	3	6	365	365	930	60	separate	100	1900
DRF3-60NS	6,0	5	9	365	365	930	60	separate	100	1900
DRF3-75NS	7,5	7	13	365	365	930	60	separate	100	1900
DRF3-90NS	9,0	8	14	365	365	930	60	separate	100	1900





Sauna HEATERS

# FLOOR Series

SAWO Floor Series features movable, high-performance, stand-alone sauna heaters that ensure optimal heat distribution and comfort, enhancing your sauna experience with sleek, durable designs.

WARNING! VARNING! VARNING! VYSTRAHA! ADVERTENCIA! WAARSCHUWING!  
WARNING! VARNING! VARNING! VYSTRAHA! ADVERTENCIA! WAARSCHUWING!  
ADVERTENCIA! OPOZORILO! VARNING! OSTRZEZENIE! FIGYELMEZTETESI! AVERTISSEMENT!

# Helius

This modern, “hidden” heater with slim shape gives you flexibility on heater placement. **Helius** requires only a small safety distance (min. 5mm), to decrease the safety distance even more minimal, add separate Helius hood. To get more space for benches, Helius can be installed behind the benches. The genius airflow design creates ventilation in the heater, which heats up air inside the sauna more efficiently. Perfect especially for small to medium sized saunas to (3m<sup>3</sup> - 14m<sup>3</sup>).

- » Power range 4.5 - 9.0kW
- » Available controlling NS
- » Separate soapstone water basin with hose
- » Sauna Experience: Hot, Sharp heat
- » Optional heater guard and Helius Hood



Helius  
(NS)





## Technical DATA

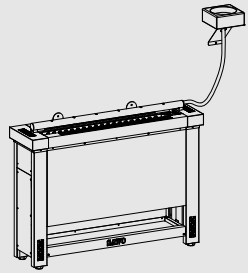

Heliuss

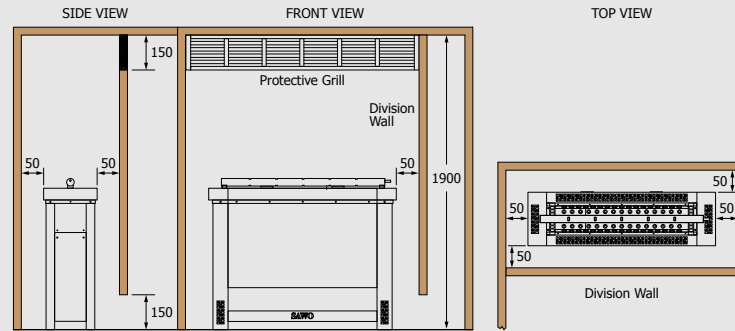

Minimum Safety Distances (Recess Wall)

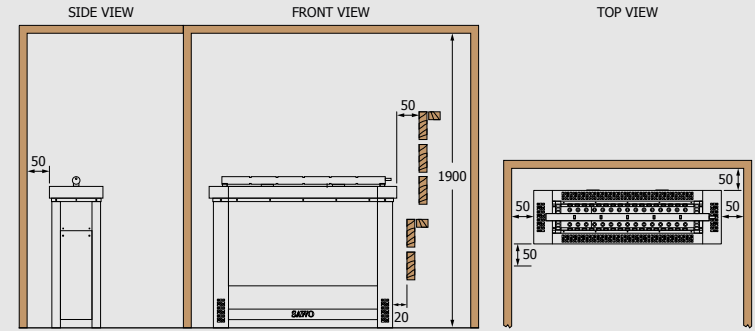

Minimum Safety Distances (Normal Installation)

### Separate Control

HEATER MODEL	kW	SAUNA ROOM		SIZE OF HEATER			STONES (kg)	CONTROL
		MIN	MAX	WIDTH	DEPTH	HEIGHT		
HES-45NS	4,5	3	6	860	230	655	19	separate
HES-60NS	6,0	5	8	860	230	655	19	separate
HES-75NS	7,5	7	12	860	230	655	19	separate
HES-90NS	9,0	8	14	860	230	655	19	separate

### Other features:

- » Floor standing
- » Stones are not in contact with heating elements
- » Water accessory is included for recess wall installation
- » Can fit 17kg of stones
- » 4,5kW - 9,0kW power
- » Catch pan included
- » Separate control
- » Adjustable legs

### Heliuss with Hood (Optional)

- » Keep a small space for wall divider to recess area so heater can go below the bench.



### Heater Accessories (Optional)

#### Heliuss Heater Guards



Wooden  
Cedar (D) & Aspen (A)

MODEL	SIZE OF GUARD RAIL (mm)		
	WIDTH	DEPTH	HEIGHT
HES-GUARD-W-D	910	278	88
HES-GUARD-W-A	910	278	88



# Taurus

**Taurus** is a professional heater with advance sensory system that detects early stage of heating element malfunctions. The rock container keeps stones separated from the heating elements which increases life span of the heating elements.

**Taurus D** revolutionizes the standard sauna heater, by having 2 heating element options in same heater. Choose between using 9kW or 12kW depending on the space the heater is installed.

- » Power range 9.0 - 24.0kW
- » Available controlling NS
- » Sauna Experience: Hot, Sharp heat to milder and more humid
- » Optional heater guard



# Technical DATA

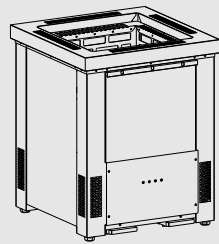

Taurus

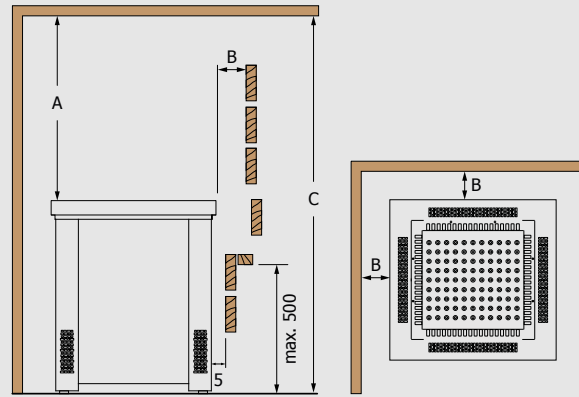

Minimum Safety Distances

Easy access to change heating elements through cassette pull-out tray.

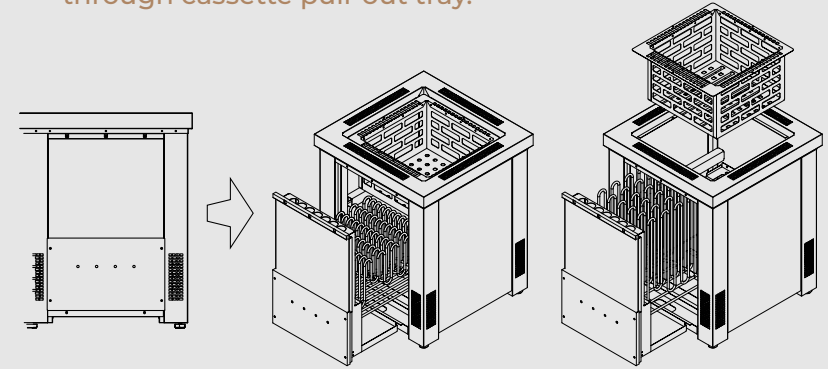

Taurus (NS)

## Taurus D

HEATER MODEL	kW	SAUNA ROOM		SIZE OF HEATER			STONES (kg)	CONTROL	MINIMUM SAFETY DISTANCES		
		MIN (m³)	MAX (m³)	WIDTH (mm)	DEPTH (mm)	HEIGHT (mm)			A	B	C
TRD-90/120NS-G-P	9,0   12,0	8	14	555	555	685	50	separate	1210	5/*50	1900
TRD-180/210/240NS-G-P	18,0   21,0   24,0	24	40	955	555	685	100	separate	1410	5/*50	2100

\*For commercial use.



Taurus Combi (NS) NEW!

## Taurus D Combi

HEATER MODEL	kW	SAUNA ROOM		SIZE OF HEATER			STONES (kg)	CONTROL	MINIMUM SAFETY DISTANCES		
		MIN (m³)	MAX (m³)	WIDTH (mm)	DEPTH (mm)	HEIGHT (mm)			A	B	C
TRDC-90/120NS-G-P	9,0   12,0	8	14	555	595	685	50	separate	1210	5/*50	1900
TRDC-180/210/240NS-G-P	18,0   21,0   24,0	24	40	955	595	685	100	separate	1410	5/*50	2100

\*For commercial use.

## Heater Accessories (Optional)

### Taurus Heater Guards



Wooden Heater Guard for TRD-90/120 Cedar (D), Aspen (A), & Black (BL)

MODEL	SIZE OF GUARD RAIL (mm)		
	WIDTH	DEPTH	HEIGHT
TAU-GUARD-W9-D   A   BL	554	102	135

Wooden Heater Guard for TRD-180/210/240 Cedar (D), Aspen (A), & Black (BL)

MODEL	SIZE OF GUARD RAIL (mm)		
	WIDTH	DEPTH	HEIGHT
TAU-GUARD-V12-D   A   BL	102	704	135

### Heater Guard Rails





# Krios Floor

**Krios** is now available also as floor heater with same stainless steel casing with signature SAWO-pattern. With more stones, Krios gives more steam. Perfect especially for medium to large sized saunas to bring smooth and humid heat (8m<sup>3</sup> - 42m<sup>3</sup>).



## Technical DATA

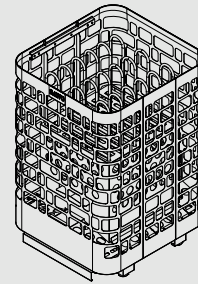

Krios Floor

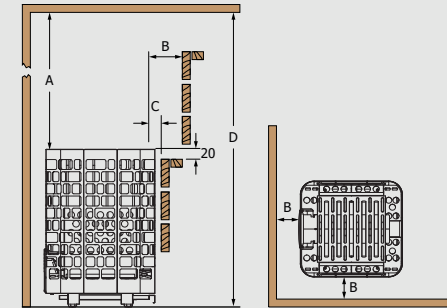

Minimum Safety Distances

## Separate Control

HEATER MODEL	kW	SAUNA ROOM		SIZE OF HEATER			STONES (kg)	CONTROL	MINIMUM SAFETY DISTANCES			
		MIN (m <sup>3</sup> )	MAX (m <sup>3</sup> )	WIDTH (mm)	DEPTH (mm)	HEIGHT (mm)			A	B	C	D
KRFS-90NS	9,0	8	14	500	460	715	160	separate	1200	100	20	1900
KRFS-105NS	10,5	9	15	500	460	715	160	separate	1200	100	20	1900
KRFS-120NS	12,0	10	18	500	460	715	160	separate	1400	100	20	2100
KRFS-150NS	15,0	13	23	680	460	715	210	separate	1400	100	160	2100
KRFS-180NS	18,0	17	29	680	460	715	210	separate	1400	100	160	2100
KRFS-180NS-V12	18,0	18	30	860	460	715	260	separate	1400	160	100	2100
KRFS-210NS-V12	21,0	22	35	860	460	715	260	separate	1400	160	100	2100
KRFS-240NS-V12	24,0	26	42	860	460	715	260	separate	1400	160	100	2100



Krios Floor (NS)

- » Power range 9.0 - 24.0kW
- » Available controlling NS
- » Sauna Experience: Medium smooth heat, Humid

# Savonia

**Savonia** models are electric heaters designed to withstand extreme heat with only little care and maintenance. They can handle large amount of stones for more pleasant sauna steam. Savonia heaters are with adjustable leg support that keeps the heater stand leveled on the floor. Suitable for especially for commercial saunas. Perfect especially for medium to large sized saunas to (8m<sup>3</sup> - 42m<sup>3</sup>).

Available with cool-to-touch fiber coating.

- » Power range 9.0 - 24.0kW
- » Available controlling NS
- » Sauna Experience: Medium heat, with mild steam

## Technical DATA

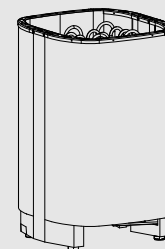

Savonia

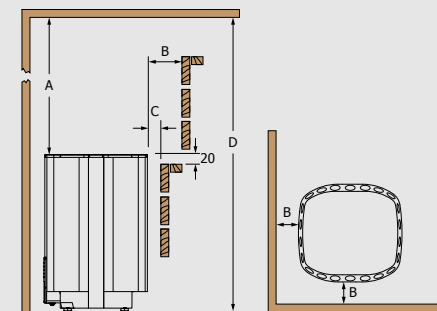

Minimum Safety Distances



## Separate Control

HEATER MODEL	kW	SAUNA ROOM (m <sup>3</sup> )		SIZE OF HEATER (mm)			STONES (kg)	CONTROL	MINIMUM SAFETY DISTANCES (mm)			
		MIN	MAX	WIDTH	DEPTH	HEIGHT			A	B	C	D
SAV-90NS	9,0	8	14	440	420	655	50	separate	1200	110	50	1900
SAV-105NS	10,5	9	15	440	420	655	50	separate	1200	120	60	1900
SAV-120NS	12,0	10	18	440	420	655	50	separate	1400	130	70	2100
SAV-150NS	15,0	13	23	590	420	655	75	separate	1400	160	100	2100
SAV-180NS	18,0	17	29	590	420	655	75	separate	1400	160	100	2100
SAV-180NS-V12	18,0	18	30	740	420	655	100	separate	1400	160	100	2100
SAV-210NS-V12	21,0	22	35	740	420	655	100	separate	1400	160	100	2100
SAV-240NS-V12	24,0	26	42	740	420	655	100	separate	1400	160	100	2100



Savonia (NS)



Savonia Fibercoated (NS)



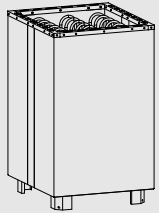

Nordex FLOOR

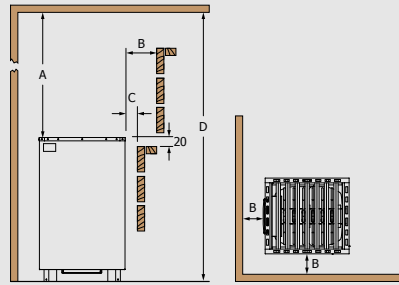

Minimum Safety Distances

- » Power range 9.0 - 24.0kW
- » Available controlling NS
- » Sauna Experience: Hot, Sharp heat

Separate Control

HEATER MODEL	kW	SAUNA ROOM (m³)		SIZE OF HEATER			STONES (KG)	CONTROL	MINIMUM SAFETY DISTANCES			
		MIN	MAX	WIDTH	DEPTH	HEIGHT			A	B	C	D
NRFS-90NS	9,0	8	14	450	400	670	50	separate	1200	120	50	1900
NRFS-105NS	10,5	9	15	450	400	670	50	separate	1200	120	60	1900
NRFS-120NS	12,0	10	18	450	400	670	50	separate	1400	130	70	2100
NRFS-150NS	15,0	13	23	595	400	670	75	separate	1400	160	100	2100
NRFS-180NS	18,0	17	29	595	400	670	75	separate	1400	160	100	2100
NRFS-180NS-V12	18,0	18	30	740	400	670	100	separate	1400	160	100	2100
NRFS-210NS-V12	21,0	22	35	740	400	670	100	separate	1400	160	100	2100
NRFS-240NS-V12	24,0	26	42	740	400	670	100	separate	1400	160	100	2100



Nordex Floor (NS)



Nordex Floor Black (NS)

# Nordex Floor

**Nordex floor** is a floor-standing heater with simple and minimalist design. Available with black metal casing. Perfect especially for medium to large sized saunas to bring smooth and humid heat (8m<sup>3</sup> - 42m<sup>3</sup>).





# Nordex S

**Nordex S** is new version of Nordex Floor with sleeker design. This heater can be placed easily to different sauna room layout due to the slimmer design. Also available with black metal casing. Perfect especially for medium sized saunas (5m<sup>3</sup> - 14m<sup>3</sup>).



## Technical DATA



Nordex S

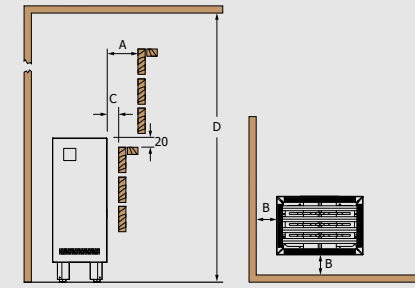

Minimum Safety Distances

- » Power range 6.0 - 9.0kW
- » Available controlling NS
- » Sauna Experience: Hot, Sharp heat

### Separate Control

HEATER MODEL	kW	SAUNA ROOM (m <sup>3</sup> )		SIZE OF HEATER (mm)			STONES (kg)	CONTROL	MINIMUM SAFETY DISTANCES			
		MIN	MAX	WIDTH	DEPTH	HEIGHT			A	B	C	D
NRNS-6ONS	6,0	5	9	270	395	710	18 - 25	separate	50	50	5	1900
NRNS-6ONS-BL	6,0	5	9	270	395	710	18 - 25	separate	50	50	5	1900
NRNS-8ONS	8,0	7	13	270	395	710	18 - 25	separate	80	80	5	1900
NRNS-8ONS-BL	8,0	7	13	270	395	710	18 - 25	separate	80	80	5	1900
NRNS-9ONS	9,0	8	14	270	395	710	18 - 25	separate	80	80	5	1900
NRNS-9ONS-BL	9,0	8	14	270	395	710	18 - 25	separate	80	80	5	1900

### Nordex S with LED Lights (Optional)

MODEL
NRNS-6ONS-L-Z-C   NRNS-6ONS-BL-L-Z-C
NRNS-8ONS-L-Z-C   NRNS-8ONS-BL-L-Z-C
NRNS-9ONS-L-Z-C   NRNS-9ONS-BL-L-Z-C



Nordex S (NS)



Nordex S Black (NS)



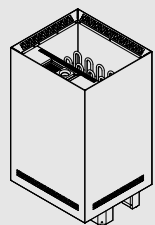

Nordex S Combi

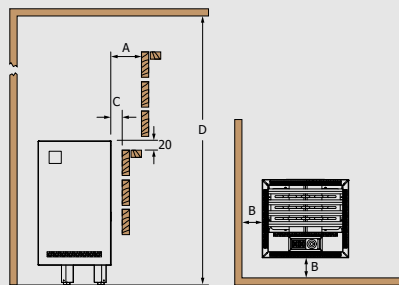

Minimum Safety Distances

- » Power range 6.0 - 9.0kW
- » Available controlling NS
- » Separate water tank with 0.8kW or 2kW steam generator
- » Built-in aroma cups for aroma therapy
- » Sauna Experience: Hot, Sharp heat to Milder steam

Separate Control

HEATER MODEL	kW	SAUNA ROOM (m³)		SIZE OF HEATER			STONES (kg)	CONTROL	MINIMUM SAFETY DISTANCES			
		MIN	MAX	WIDTH	DEPTH (mm)	HEIGHT			A	B	C	D
NRNC-60NS	6,0	5	9	270	395	710	8	separate	5	50	5	1990
NRNC-60NS-BL	6,0	5	9	270	395	710	8	separate	5	50	5	1990
NRNC-80NS	8,0	7	13	270	395	710	8	separate	5	80	5	1990
NRNC-80NS-BL	8,0	7	13	270	395	710	8	separate	5	80	5	1990
NRNC-90NS	9,0	8	14	270	395	710	8	separate	5	80	5	1990
NRNC-90NS-BL	9,0	8	14	270	395	710	8	separate	5	80	5	1990



Nordex S Combi (NS)



Nordex S Combi Black (NS)

# Nordex S Combi

The **Nordex S Combi** is now available in a steamier version. Balance the intense heat with an additional water tank for more steam. Also available with a black metal casing, it's perfect for medium-sized saunas (5m³ - 14m³).





Sauna HEATERS

# WALL- Mounted Series

SAWO Wall-mounted heaters are for those who love the traditional dry and hot sauna experience. From these classic heaters you can find robust and space-saving models for small and medium size saunas.

For additional safety, most of the SAWO wall-mounted heaters are available with cool-to-touch fibercoating. This will help to avoid any accidental burns with the heater.



Mini  
(NB)



Mini  
Fibercoated  
(NB)



Mini X  
(NS | NB)



Mini X  
Fibercoated  
(NS | NB)



Mini Combi  
(NS)



Mini Combi  
Fibercoated  
(NS)

## Mini

**Mini** heater is the solution for small, 1 – 2 persons sauna rooms. Due to its small size and from left to right reversible control unit, Mini heater can be placed in very small locations. Available also with cool-to-touch fiber-coating.

Best for small sauna (1.3m<sup>3</sup> - 6m<sup>3</sup>).

- » Power range 2.3 - 3.6kW
- » Available controlling NB
- » Sauna Experience: Hot, Sharp heat

## Mini X

**Mini X** is an ideal heater for sauna rooms with extremely limited space. It is placed in corner of sauna room, allowing the maximum space for sauna use. Available also with cool-to-touch fiber-coating.

Best for small sauna (1.3m<sup>3</sup> - 6m<sup>3</sup>).

- » Power range 2.3 - 3.6kW
- » Available controlling NS, NB
- » Sauna Experience: Hot, Sharp heat

## Mini Combi

**Mini** heater with additional combi water tank for increased humidity. Available also with cool-to-touch fiber-coating.

Best for small sauna (2m<sup>3</sup> - 6m<sup>3</sup>).

- » Power range 3.0 - 3.6kW
- » Available controlling NS
- » Separate water tank with 1kW steam generator
- » Built-in aroma cup for aroma therapy
- » Sauna Experience: Hot, Sharp heat to mildly humid



# Technical DATA

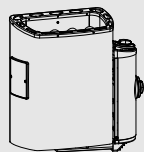

Mini

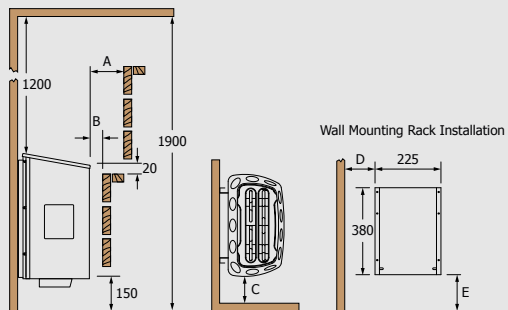

Minimum Safety Distances

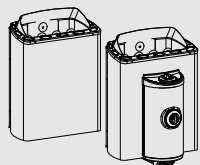

Mini X

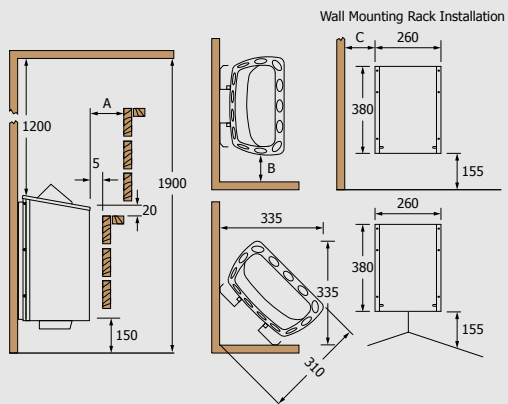

Minimum Safety Distances

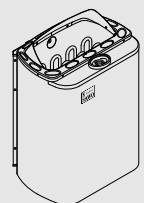

Mini Combi

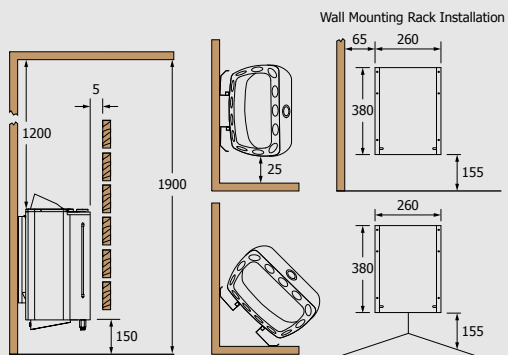

Minimum Safety Distances

## Built-in Control

HEATER MODEL	kW	SAUNA ROOM		SIZE OF HEATER			STONES (kg)	CONTROL	MINIMUM SAFETY DISTANCES				
		MIN (m³)	MAX (m³)	WIDTH	DEPTH (mm)	HEIGHT			A	B	C	D	E
MN-23NB	2,3	1,3	2,5	435	*215	**455	11	built-in	100	20	100	140	155
MN-30NB	3,0	2	4	435	*215	**455	11	built-in	100	20	100	140	155
MN-36NB	3,6	3	6	435	*215	**455	11	built-in	100	20	100	140	155

\*Depth when installed to the wall.

\*\*Reflector not included.

## Separate Control

HEATER MODEL	kW	SAUNA ROOM		SIZE OF HEATER			STONES (kg)	CONTROL	MINIMUM SAFETY DISTANCES		
		MIN (m³)	MAX (m³)	WIDTH	DEPTH (mm)	HEIGHT			A	B	C
MX-23NS	2,3	1,3	2,5	330	*200/320	495	11	separate	30	20	60
MX-30NS	3,0	2	4	330	*200/320	495	11	separate	35	25	65
MX-36NS	3,6	3	6	330	*200/320	495	11	separate	40	25	65

## Built-in Control

HEATER MODEL	kW	SAUNA ROOM		SIZE OF HEATER			STONES (kg)	CONTROL	MINIMUM SAFETY DISTANCES		
		MIN (m³)	MAX (m³)	WIDTH	DEPTH (mm)	HEIGHT			A	B	C
MX-23NB	2,3	1,3	2,5	330	*310/435	485	11	built-in	30	20	60
MX-30NB	3,0	2	4	330	*310/435	485	11	built-in	35	25	65
MX-36NB	3,6	3	6	330	*310/435	485	11	built-in	40	25	65

\*Wall mounted/corner mounted.

## Combi Control

HEATER MODEL	kW	SAUNA ROOM		SIZE OF HEATER			STONES (kg)	CONTROL
		MIN (m³)	MAX (m³)	WIDTH	DEPTH (mm)	HEIGHT		
MNC-23NS	2,3	2	4	330	*260	500	8-10,5	separate
MNC-23NSF	2,3	2	4	330	*260	500	8-10,5	separate
MNC-30NS	3,0	2	4	330	*260	500	8-10,5	separate
MNC-30NSF	3,0	2	4	330	*260	500	8-10,5	separate
MNC-36NS	3,6	3	6	330	*260	500	8-10,5	separate
MNC-36NSF	3,6	3	6	330	*260	500	8-10,5	separate

\*Depth when installed to the wall.

\*\*Reflector not included.

# Scandia

**Scandia** is a stable classic of sauna heaters. This simple heater gives the traditional Finnish sauna experience. Available also with cool-to-touch fiber-coating.

Best for small to medium sized sauna (3m<sup>3</sup> - 14m<sup>3</sup>).

- » Power range 4.5 - 9.0kW
- » Available controlling NS, NB
- » Sauna Experience: Hot, Sharp heat



## Technical DATA

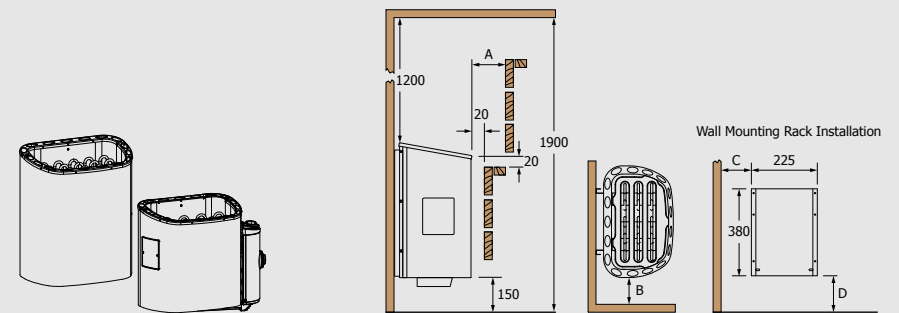

Scandia

Minimum Safety Distances



Scandia (NS)

Scandia Fibercoated (NS)

Scandia (NB)

Scandia Fibercoated (NB)

## Separate Control

HEATER MODEL	kW	SAUNA ROOM		SIZE OF HEATER			STONES (kg)	CONTROL	MINIMUM SAFETY DISTANCES			
		MIN (m <sup>3</sup> )	MAX (m <sup>3</sup> )	WIDTH	DEPTH (mm)	HEIGHT			A	B	C	D
SCA-45NS	4,5	3	6	410	*290	**455	22	separate	100	100	135	155
SCA-60NS	6,0	5	8	410	*290	**455	22	separate	100	100	135	155
SCA-80NS	8,0	7	13	410	*290	**525	22	separate	100	100	135	235
SCA-90NS	9,0	8	14	410	*290	**525	22	separate	100	100	135	235

## Built-in Control

HEATER MODEL	kW	SAUNA ROOM		SIZE OF HEATER			STONES (kg)	CONTROL	MINIMUM SAFETY DISTANCES			
		MIN (m <sup>3</sup> )	MAX (m <sup>3</sup> )	WIDTH	DEPTH (mm)	HEIGHT			A	B	C	D
SCA-45NB	4,5	3	6	515	*290	**455	22	built-in	100	100	185	155
SCA-60NB	6,0	5	8	515	*290	**455	22	built-in	100	100	185	155
SCA-80NB	8,0	7	13	515	*290	**525	22	built-in	100	100	185	235
SCA-90NB	9,0	8	14	515	*290	**525	22	built-in	100	100	185	235

\*Depth when installed to the wall.

\*\*Reflector not included.



# Scandia Combi

- Scandia heater** with additional combi water tank for increased humidity. Available also with cool-to-touch fiber-coating.
- » Power range 6 - 9.0kW
  - » Available controlling NS
  - » Separate water tank with 1kW or 2kW steam generator
  - » Built-in aroma cup for aroma therapy
  - » Sauna Experience: Hot, Sharp heat to mildly humid
- Best for small to medium sized sauna (5m<sup>3</sup> - 14m<sup>3</sup>).



## Technical DATA

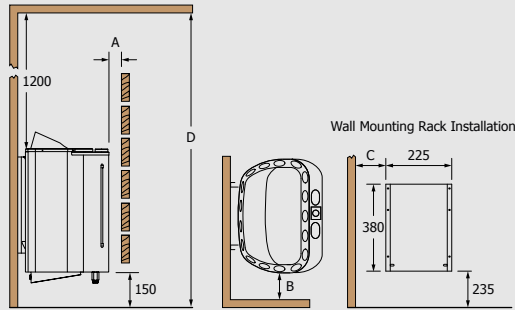
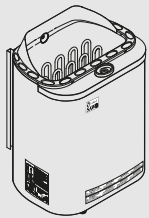

Scandia Combi

Minimum Safety Distances for Scandia Combi

## Combi Control

HEATER MODEL	kW	SAUNA ROOM		SIZE OF HEATER			STONES (kg)	CONTROL	MINIMUM SAFETY DISTANCES			
		MIN (m <sup>3</sup> )	MAX (m <sup>3</sup> )	WIDTH	DEPTH (mm)	HEIGHT			A	B	C	D
SCAC-60NS	6,0	5	9	410	*365	595	18-22	separate	5	50	135	1900
SCAC-80NS	8,0	7	13	410	*365	595	18-22	separate	5	50	135	1900
SCAC-90NS	9,0	8	14	410	*365	595	18-22	separate	5	50	135	1900

\*Depth when installed to the wall.



Scandia Combi (NS)



Scandia Combi Fibercoated (NS)

# Krios

This beautiful wall-mounted heater has stainless steel casing with signature SAWO-pattern. Inspired by Aries and Cubos models, this heater is something you have never seen before.

With more stones, **Krios** gives more steam. Perfect especially for small and medium sized saunas to bring smooth and humid heat.



Krios  
(Ni2)



Krios  
(NS)



Krios  
(NB)



## Technical DATA

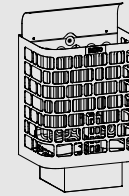

Krios

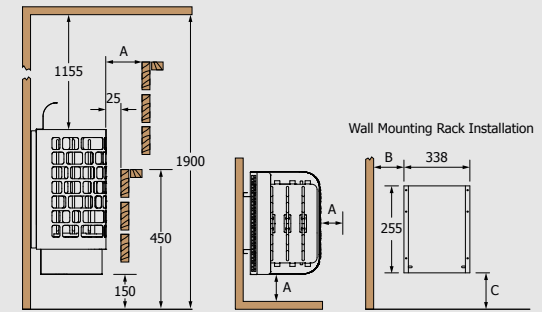

Minimum Safety Distances

### Ni2 Version

HEATER MODEL	kW	SAUNA ROOM		SIZE OF HEATER			STONES (kg)	CONTROL	MINIMUM SAFETY DISTANCES		
		MIN (m³)	MAX	WIDTH	DEPTH	HEIGHT			A	B	C
KRI-45Ni2	4,5	3	6	390	*290	**600	40	Saunova 2.0	50	75	345
KRI-60Ni2	6,0	5	9	390	*290	**600	40	Saunova 2.0	80	105	345
KRI-80Ni2	8,0	7	13	390	*290	**670	50	Saunova 2.0	100	125	415
KRI-90Ni2	9,0	8	14	390	*290	**670	50	Saunova 2.0	100	125	415

### Separate Control

HEATER MODEL	kW	SAUNA ROOM		SIZE OF HEATER			STONES (kg)	CONTROL	MINIMUM SAFETY DISTANCES		
		MIN (m³)	MAX	WIDTH	DEPTH	HEIGHT			A	B	C
KRI-45NS	4,5	3	6	390	*290	**580	40	Innova	50	75	320
KRI-60NS	6,0	5	9	390	*290	**580	40	Innova	80	105	320
KRI-80NS	8,0	7	13	390	*290	**650	50	Innova	100	125	390
KRI-90NS	9,0	8	14	390	*290	**650	50	Innova	100	125	390

### Built-in Control

HEATER MODEL	kW	SAUNA ROOM		SIZE OF HEATER			STONES (kg)	CONTROL	MINIMUM SAFETY DISTANCES		
		MIN (m³)	MAX	WIDTH	DEPTH	HEIGHT			A	B	C
KRI-45NB	4,5	3	6	390	*290	**580	40	Built-in	50	75	320
KRI-60NB	6,0	5	9	390	*290	**580	40	Built-in	80	105	320
KRI-80NB	8,0	7	13	390	*290	**650	50	Built-in	100	125	390
KRI-90NB	9,0	8	14	390	*290	**650	50	Built-in	100	125	390

\*Depth when installed to the wall.

\*\*Height with reflector.



## Krios

- » Wall mounted
- » Stainless steel casing
- » Heat reflector included
- » Control can be rotated to left, front and right
- » Can fit 50kg of stones
- » 4,5kW - 9,0kW power
- » Built-in, separate, Ni2 control

### Heater Accessories (Optional)

#### Krios Heater Guards

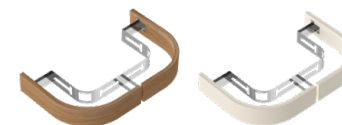

Wooden  
Cedar (D) & Aspen (A)

MODEL	SIZE OF GUARD RAIL		
	WIDTH (mm)	DEPTH (mm)	HEIGHT (mm)
KRI-GUARD-W-D	388	112	690
KRI-GUARD-W-A	388	112	690





# Nordex

**Nordex** heater with minimalist and modern design. This heater is also available with black metal casing.

- » Power range 4.5 - 9.0kW
- » Available controlling Ni2, NS, NB
- » Sauna Experience: Hot, Sharp heat

Perfect especially for small to medium sized saunas to (3m<sup>3</sup> - 14m<sup>3</sup>).



Nordex (Ni2)

Nordex Black (Ni2)

Nordex (NS)

Nordex Black (NS)



Nordex (NB)



Nordex Black (NB)



## Technical DATA

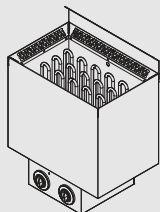

Nordex

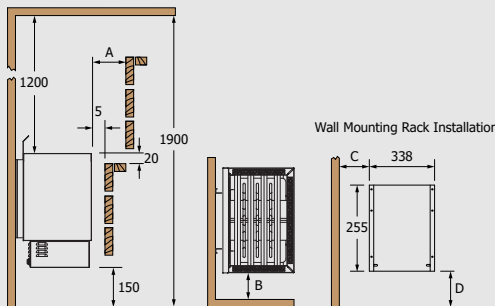

Minimum Safety Distances

## Ni2 Version

HEATER MODEL	kW	SAUNA ROOM		SIZE OF HEATER			STONES (kg)	CONTROL	MINIMUM SAFETY DISTANCES			
		MIN (m <sup>3</sup> )	MAX (m <sup>3</sup> )	WIDTH	DEPTH (mm)	HEIGHT			A	B	C	D
NR-45Ni2	4,5	3	6	410	*300	**510	22	Saunova 2.0	50	50	130	270
NR-60Ni2	6,0	5	9	410	*300	**510	22	Saunova 2.0	50	50	130	270
NR-80Ni2	8,0	7	13	410	*300	**585	22	Saunova 2.0	80	80	160	330
NR-90Ni2	9,0	8	14	410	*300	**585	22	Saunova 2.0	80	80	160	330

## Built-in | Separate Control

HEATER MODEL	kW	SAUNA ROOM		SIZE OF HEATER			STONES (kg)	CONTROL	MINIMUM SAFETY DISTANCES			
		MIN (m <sup>3</sup> )	MAX (m <sup>3</sup> )	WIDTH	DEPTH (mm)	HEIGHT			A	B	C	D
NR-45NB NS	4,5	3	6	400	*295	**515	18-22	8 + 4h	50	50	80	320
NR-60NB NS	6,0	5	9	400	*295	**515	18-22	8 + 4h	50	50	80	320
NR-80NB NS	8,0	7	13	400	*295	**590	18-22	8 + 4h	80	80	110	395
NR-90NB NS	9,0	8	14	400	*295	**590	18-22	8 + 4h	80	80	110	395

\*Depth when installed to the wall.  
\*\*Height with reflector.

## Heater Accessories (Optional)

### Nordex Heater Guards

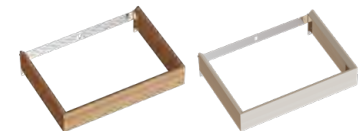

Wooden Cedar (D) & Aspen (A)

MODEL	SIZE OF GUARD RAIL (mm)		
	WIDTH	DEPTH	HEIGHT
NRN-GUARD-W-D	462	100	75
NRN-GUARD-W-A	462	100	75

# Nordex Combi

- Nordex** in combi version, helps to add humidity to the heat. This heater is also available with black metal casing.
- Perfect especially for small to medium sized saunas to (5m<sup>3</sup> - 14m<sup>3</sup>).
- » Power range 6.0 - 9.0kW
  - » Available controlling NS
  - » Separate water tank with 0.8kW or 2kW steam generator
  - » Built-in aroma cups for aroma therapy
  - » Sauna Experience: Hot, Sharp heat to milder humid heat

## Combi Control

HEATER MODEL	kW	SAUNA ROOM		SIZE OF HEATER			STONES (kg)	CONTROL
		MIN (m <sup>3</sup> )	MAX (m <sup>3</sup> )	WIDTH	DEPTH (mm)	HEIGHT (mm)		
NRC-60NS	6,0	5	9	410	*365	**580	22	Innova
NRC-80NS	8,0	7	13	410	*365	**580	22	Innova
NRC-90NS	9,0	8	14	410	*365	**580	22	Innova

\*Depth when installed to the wall.

\*\*Height with reflector.



Nordex Combi (NS)



Nordex Combi Black (NS)



## Technical DATA

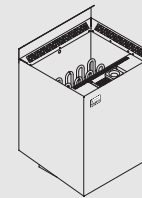

Nordex Combi

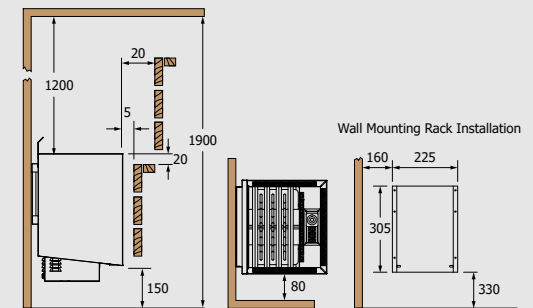

Minimum Safety Distances

# Nordex Mini

**Nordex Mini** can be wall-mounted in straight or corner position. This heater is also available with black metal casing.

Perfect especially for small sized saunas to (1.3m<sup>3</sup> - 6m<sup>3</sup>).

- » Power range 2.3 - 3.60kW
- » Available controlling Ni2, NS, NB
- » Sauna Experience: Hot, Sharp heat

! For more technical information, see page 57.



Nordex Mini (Ni2)

Nordex Mini Black (Ni2)



Nordex Mini (NS)

Nordex Mini Black (NS)



Nordex Mini (NB)

Nordex Mini Black (NB)

# Nordex Mini Combi

**Nordex Mini** in combi version, helps to add humidity to the heat. This heater is also available with black metal casing.

Perfect especially for small sized saunas to (12m<sup>3</sup> - 6m<sup>3</sup>).

- » Power range 3 - 3.6kW
- » Available controlling NS
- » Separate water tank with 0.8kW steam generator
- » Built-in aroma cups for aroma therapy
- » Sauna Experience: Hot, Sharp heat to milder humid heat

! For more technical information, see page 57.



Nordex Mini Combi  
(NS)



Nordex Mini Combi  
Black  
(NS)



# Technical DATA

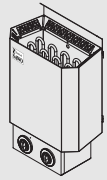

Nordex MINI

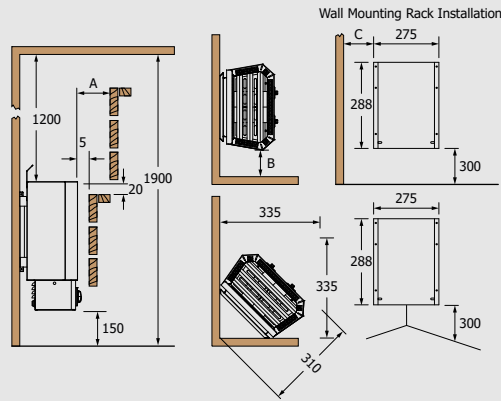

Minimum Safety Distances

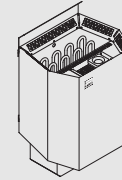

Nordex Mini Combi

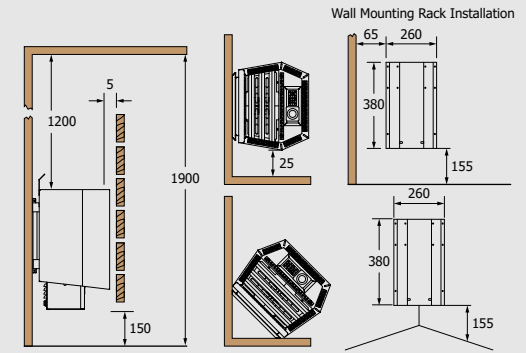

Minimum Safety Distances

## Ni2 Version

HEATER MODEL	kW	SAUNA ROOM (m³)		SIZE OF HEATER			STONES (kg)	CONTROL	MINIMUM SAFETY DISTANCES		
		MIN	MAX	WIDTH	DEPTH (mm)	HEIGHT			A	B	C
NRMN-23Ni2	2,3	1,3	2,5	340	*200	500	11	Saunova	50	30	85
NRMN-30Ni2	3,0	2	4	340	*200	500	11	Saunova	50	30	85
NRMN-36Ni2	3,6	3	6	340	*200	500	11	Saunova	50	30	85

## Combi Control

HEATER MODEL	kW	SAUNA ROOM (m³)		SIZE OF HEATER			STONES (kg)	CONTROL
		MIN	MAX	WIDTH	DEPTH (mm)	HEIGHT		
NRMNC-30NS Ni2	3,0	2	4	340	*240	500	11	separate Saunova
NRMNC-36NS Ni2	3,6	3	6	340	*240	500	11	separate Saunova

\*Depth when installed to the wall.

## Built-in | Separate Control

HEATER MODEL	kW	SAUNA ROOM (m³)		SIZE OF HEATER			STONES (kg)	CONTROL	MINIMUM SAFETY DISTANCES		
		MIN	MAX	WIDTH	DEPTH (mm)	HEIGHT			A	B	C
NRMN-23NB NS	2,3	1,3	2,5	340	*200	500	11	built-in separate	30 50	20 30	60 85
NRMN-30NB NS	3,0	2	4	340	*200	500	11	built-in separate	35 50	25 30	65 85
NRMN-36NB NS	3,6	3	6	340	*200	500	11	built-in separate	40 50	25 30	65 85

\*Depth when installed to the wall.



# Scandifire

**Scandifire** by *Stefan Lindfors* gives new life to timeless classic heater Scandia. The junglefired pattern is both playful and bold, when its combined to fiber coating it makes this heater both safe and stylish.

! For more technical information, see page 60.

## Scandifire

- » Power range 4,5 - 9kW
- » Fibercoated casing with junglefired pattern
- » Wall mounted
- » Can fit 22kg of stones
- » Built-in or separate control
- » Built-in models: Control knobs are with light indicator
- » Coating shields the heater from moisture and high temperature



Scandifire Red  
(NB)



Scandifire Black  
(NB)



Scandifire Red  
(NS)



Scandifire Black  
(NS)





# Minidragon

**Minidragon** is the smallest design heater by *Stefan Lindfors*. Its innovative fiber coating stays cool throughout the sauna session, adding safety to layouts where space is limited.

! For more technical information, see page 60.



Minidragon Red (NB)



Minidragon Black (NB)



Minidragon Red (NS)



Minidragon Black (NS)

## Minidragon

- » Power range 2,3kW - 3,6kW
- » Fibercoated casing with junglefire pattern
- » Wall mounted
- » Can fit 11kg of stones
- » Built-in or separate control
- » Built-in models: Control knobs are with light indicator





Sauna HEATERS

# STONE Series

SAWO Stone Heaters combine durable stainless steel and heat-conducting Finnish soapstone, drying the sauna room quickly after use. The Stone Series offers a perfect heater for every type of sauna.



# Nimbus

**Nimbus** heater is a one-of-a-kind heater design with impressive soapstone casing. This heater takes a bit longer time to heat, but once it does, it stores the heat and keeps on releasing warm and humid steam for hours.

Best for medium and large sized saunas (8m<sup>3</sup> - 42m<sup>3</sup>).

- » Power range 9.0 - 24.0kW
- » Control: Saunova 2.0 operated
- » Built-in aroma cups
- » Sauna Experience: Mild Mellow heat, Humid

## Separate Control

HEATER MODEL	kW	SAUNA ROOM		SIZE OF HEATER			STONES SOAPSTONES		CONTROL	MINIMUM SAFETY DISTANCES			
		MIN (m <sup>3</sup> )	MAX	WIDTH	DEPTH	HEIGHT	(kg)	(kg)		A	B	C	D
NIM-90NS	9,0	8	14	520	470	690	50	80	separate	1200	110	50	1900
NIM-105NS	10,5	9	15	520	470	690	50	80	separate	1200	120	60	1900
NIM-120NS	12,0	10	18	520	470	690	50	80	separate	1400	130	70	2100
NIM-150NS	15,0	13	23	660	470	690	75	100	separate	1400	160	100	2100
NIM-180NS	18,0	17	29	660	470	690	75	100	separate	1400	160	100	2100
NIM-180NS-V12	18,0	18	30	820	470	690	100	120	separate	1400	160	100	2100
NIM-210NS-V12	21,0	22	35	820	470	690	100	120	separate	1400	160	100	2100
NIM-240NS-V12	24,0	26	42	820	470	690	100	120	separate	1400	160	100	2100



Nimbus (NS)



## Technical DATA

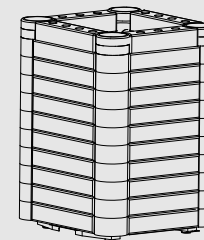

Nimbus

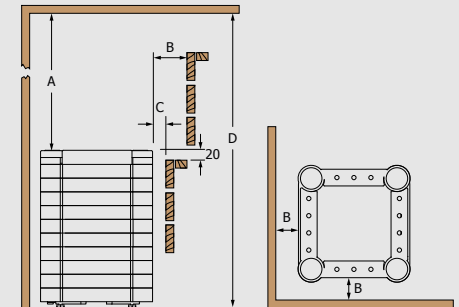

Minimum Safety Distances



# Nimbus Combi

The combi version of **Nimbus** heater adds more steam with a separate water tank. Control the amount of steam released from the tank to have perfect balance of heat and humidity.

Best for large sized saunas (8m<sup>3</sup> - 29m<sup>3</sup>).

- » Power range 9.0 - 18.0kW
- » Available controlling NS
- » Built-in aroma cups
- » Optional auto-refill, for automatically filled water tank
- » Sauna Experience: Mild Mellow heat, Very Humid

## Technical DATA

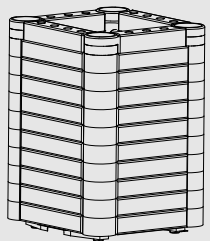

Nimbus Combi

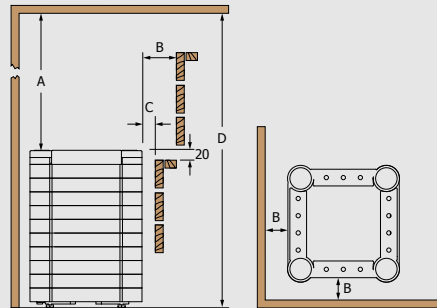

Minimum Safety Distances

## Combi Control

HEATER MODEL	kW	SAUNA ROOM (m <sup>3</sup> )		SIZE OF HEATER (mm)			STONES (kg)	SOAPSTONES (kg)	CONTROL	MINIMUM SAFETY DISTANCES			
		MIN	MAX	WIDTH	DEPTH	HEIGHT				A	B	C	D
NIMC-90NS	9,0	8	14	575	470	690	50	90	separate	1200	50	30	1900
NIMC-105NS	10,5	9	15	575	470	690	50	90	separate	1200	50	30	1900
NIMC-120NS	12,0	10	18	575	470	690	50	90	separate	1400	130	70	2100
NIMC-150NS	15,0	13	23	775	470	690	75	120	separate	1400	160	100	2100
NIMC-180NS	18,0	17	29	775	470	690	75	120	separate	1400	160	100	2100



Nimbus Combi (NS)



## Technical DATA

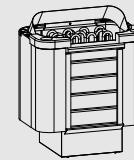

Cumulus

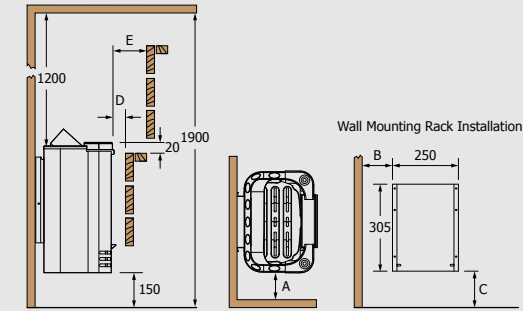

Minimum Safety Distances

# Cumulus

**Cumulus** is an elegant wall-mounted with decorative Finnish soapstone front. Add aromatherapy to your sauna by using the aroma cups provided in the top of the heater.

Best for small and medium-sized sauna (3m<sup>3</sup> - 14m<sup>3</sup>).

- » Power range 4.5 - 9.0kW
- » Available controlling Ni2, NS, NB
- » Built-in aroma cups
- » Sauna Experience: Medium heat, Humid



Cumulus  
(Ni2)

Cumulus  
(NS)

Cumulus  
(NB)

## Ni2 Version

HEATER MODEL	kW	SAUNA ROOM (m <sup>3</sup> )		SIZE OF HEATER (mm)			STONES (kg)	SOAPSTONES (kg)	CONTROL	MINIMUM SAFETY DISTANCES (mm)				
		MIN	MAX	WIDTH	DEPTH	HEIGHT				A	B	C	D	E
CML-45Ni2	4,5	3	6	420	*325	500	18	10	Saunova	50	130	245	20	50
CML-60Ni2	6,0	5	8	420	*325	500	18	10	Saunova	50	130	245	20	50
CML-80Ni2	8,0	7	13	420	*325	590	22	10	Saunova	60	140	330	30	60
CML-90Ni2	9,0	8	14	420	*325	590	22	10	Saunova	60	140	330	30	60

## Separate Control

HEATER MODEL	kW	SAUNA ROOM (m <sup>3</sup> )		SIZE OF HEATER (mm)			STONES (kg)	SOAPSTONES (kg)	CONTROL	MINIMUM SAFETY DISTANCES (mm)				
		MIN	MAX	WIDTH	DEPTH	HEIGHT				A	B	C	D	E
CML-45NS	4,5	3	6	420	*325	500	18	10	separate	50	130	245	20	50
CML-60NS	6,0	5	8	420	*325	500	18	10	separate	50	130	245	20	50
CML-80NS	8,0	7	13	420	*325	590	22	10	separate	60	140	330	30	60
CML-90NS	9,0	8	14	420	*325	590	22	10	separate	60	140	330	30	60

## Built-in Control

HEATER MODEL	kW	SAUNA ROOM (m <sup>3</sup> )		SIZE OF HEATER (mm)			STONES (kg)	SOAPSTONES (kg)	CONTROL	MINIMUM SAFETY DISTANCES (mm)				
		MIN	MAX	WIDTH	DEPTH	HEIGHT				A	B	C	D	E
CML-45NB	4,5	3	6	420	*325	500	18	10	built-in	50	130	245	20	50
CML-60NB	6,0	5	8	420	*325	500	18	10	built-in	50	130	245	20	50
CML-80NB	8,0	7	13	420	*325	590	22	10	built-in	60	140	330	30	60
CML-90NB	9,0	8	14	420	*325	590	22	10	built-in	60	140	330	30	60

\*Depth when installed to the wall.



# HEATER Accessories

## Safety Switch For Heaters



Additional safety, switch will turn off heater if foreign object is placed on top heater. Follows standard SFS-EN60335-2-53, sec 19.101



### Sauna Stones

code: R-990  
size: 20kg



### Decorative Stones

code: R-992  
size: 32pcs.

## Cozy Tank

- » Water storage that adds instant steam when heater is hot
- » Refillable water via top cover holes
- » Thick stainless metal
- » Carved soapstone top cover
- » Available in 2 designs
- » Scent pockets for sauna aroma

WATER VOLUME	HEATERS
0,7 Liter	Tower (Round, Wall, Corner), Aries (Round, Wall, Corner), Phoenix, Orion, Taurus, Mini, Mini X, Scandia, Savonia,
1,3 Liter	Nordex Mini, Nordex, Nordex Floor, Nimbus, Cumulus



### Cozy Tank 0.3L

Cylindrical Sauna Humidifier (Water Volume 0.3L)  
code: HP01-090



### Cozy Tank 0.6L

Cylindrical Sauna Humidifier (Water Volume 0.6L)  
code: HP01-070



### Cozy Tank 1.3L

Rectangular Sauna Humidifier (Water Volume 1.3L)  
code: HP01-071

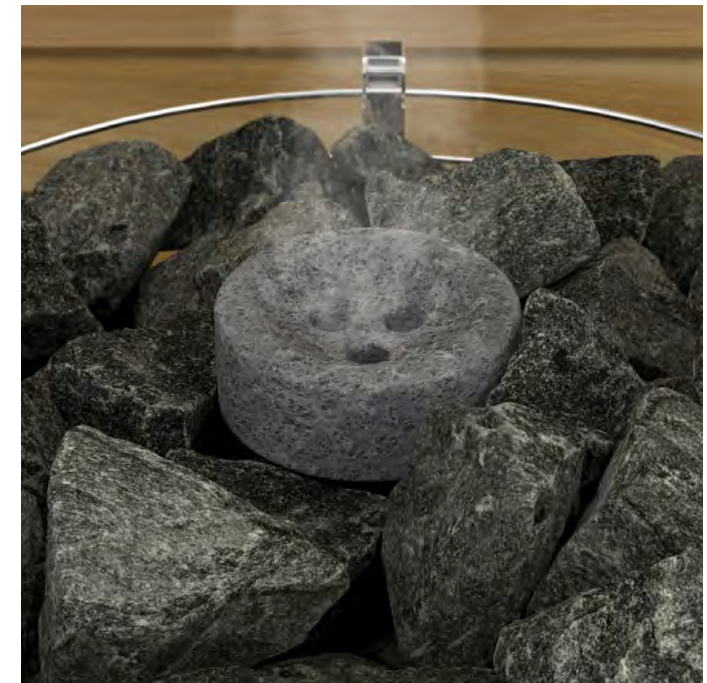



# CONTROLS

Pleasurable moments are just few clicks away.

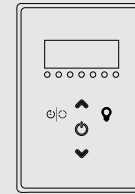

### Saunova 2.0 (SAU-UI-V2)

- » Easy and stylish user interface
- » Direct control for Ni2 heaters, for NS heaters 2.3 - 9kW add Saunova 2.0
- » Power Controller
- » More than 9kW needs a Contactor
- » Smart Controlling - feature
- » Optional Fan and Combi - feature
- » Dimensions: (W) 104 x (H) 147 x (D) 37mm

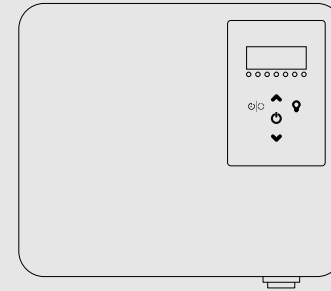

### Saunova 2.0 Built-in (SAU-B-V2)

- » Combined User Interface and Power Controller
- » For all NS Heaters 2.3 - 9kW, for 9 - 18kW add Saunova 2.0 Contactor Unit
- » Smart Controlling - feature
- » Compatible with Door Sensor
- » Optional Fan and Combi - feature
- » Dimensions: (W) 270 x (H) 320 x (D) 90mm

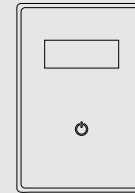

### Saunova Simple (SAU-UI-S)

- » For those looking for simplicity on sauna controlling. Enables you to focus on the basics, turning the heater on / off.
- » Dimensions: (W) 104 x (H) 147 x (D) 37mm

### Saunova 2.0 Power Controller (SAU-PC-V2)



### Saunova 2.0 Contactor Unit (SAU-PS-V2)



⚠ Needed when heater is more than 9kW power.



### Innova Classic 2.0 (INC-S-V2)

- » Connect with INP-C-V2 to use with any NS-heater or use to directly control Ni-heaters
- » Smart Controlling - feature
- » Compatible with Door Sensor
- » Optional Fan, Dimmer and Combi-feature

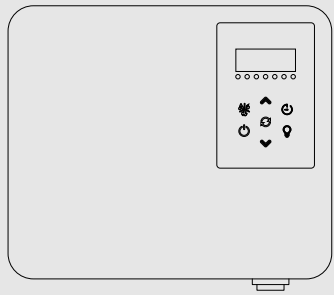

### Innova Classic 2.0 Built-in (INC-B-V2)

- » Combined User Interface and Power Controller
- » For all NS Heaters 2.3 - 15kW, connect with Innova 2.0 Contactor Unit for 15 - 28kW heaters
- » Smart Controlling - feature
- » Optional Fan, Dimmer and Combi - feature
- » Dimensions: (L) 32cm x (H) 27cm x (W) 8cm



### Innova Stainless Steel Touch (INT-S-SST)

- » Connect with INP-C to use with any NS-heater or use to directly control Ni-heaters
- » Smart Controlling - feature
- » Compatible with Door Sensor
- » Optional easy mode
- » Power blackout memory
- » Optional Fan, Dimmer and Combi - feature
- » Dimensions: (W) 147 x (H) 104 x (D) 40mm





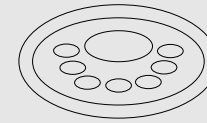

### Innova Classic (INC-S)

- » Connect with INP-C to use with any NS-heater or use to directly control Ni-heaters
- » Smart Controlling - feature
- » Compatible with Door Sensor
- » Pre-run timer
- » Optional Fan, Dimmer and Combi - feature
- » Dimensions: (W) 180 x (H) 105 x (D) 31mm

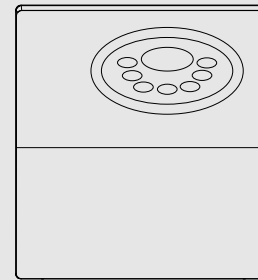

### Innova Classic Built-in (INC-B)

- » Combined User Interface and Power Controller
- » For all NS Heaters 2.3 - 15kW, connect with Innova Contactor Unit for 15 - 28kW heaters
- » Smart Controlling - feature
- » Optional Fan, Dimmer and Combi - feature
- » Dimensions: (W) 245 x (H) 265 x (D) 75mm

### Innova 2.0 Power Controller (INP-C)



### Innova 2.0 Contactor Unit (INP-S)



⚠ A Contactor Unit is needed for more than 15kW power heater.



INCLUSIONS



RJ12 Cable



Temperature Sensor



Temperature Sensor with Fuse (INN-FTEMP)



OPTIONAL ITEMS

Interface Holders



» for Saunova 2.0, Classic 2.0, Stainless Steel Touch, Classic and Steam controls.

Temperature Sensors



Optional Second Temperature Sensor for Bench Area (INN-BTEMP)



Optional Humidity and Temperature Sensor for Bench Area (INN-HUM)

# Sauna ACCESSORIES

Fulfill sauna design with outstanding sauna accessories.

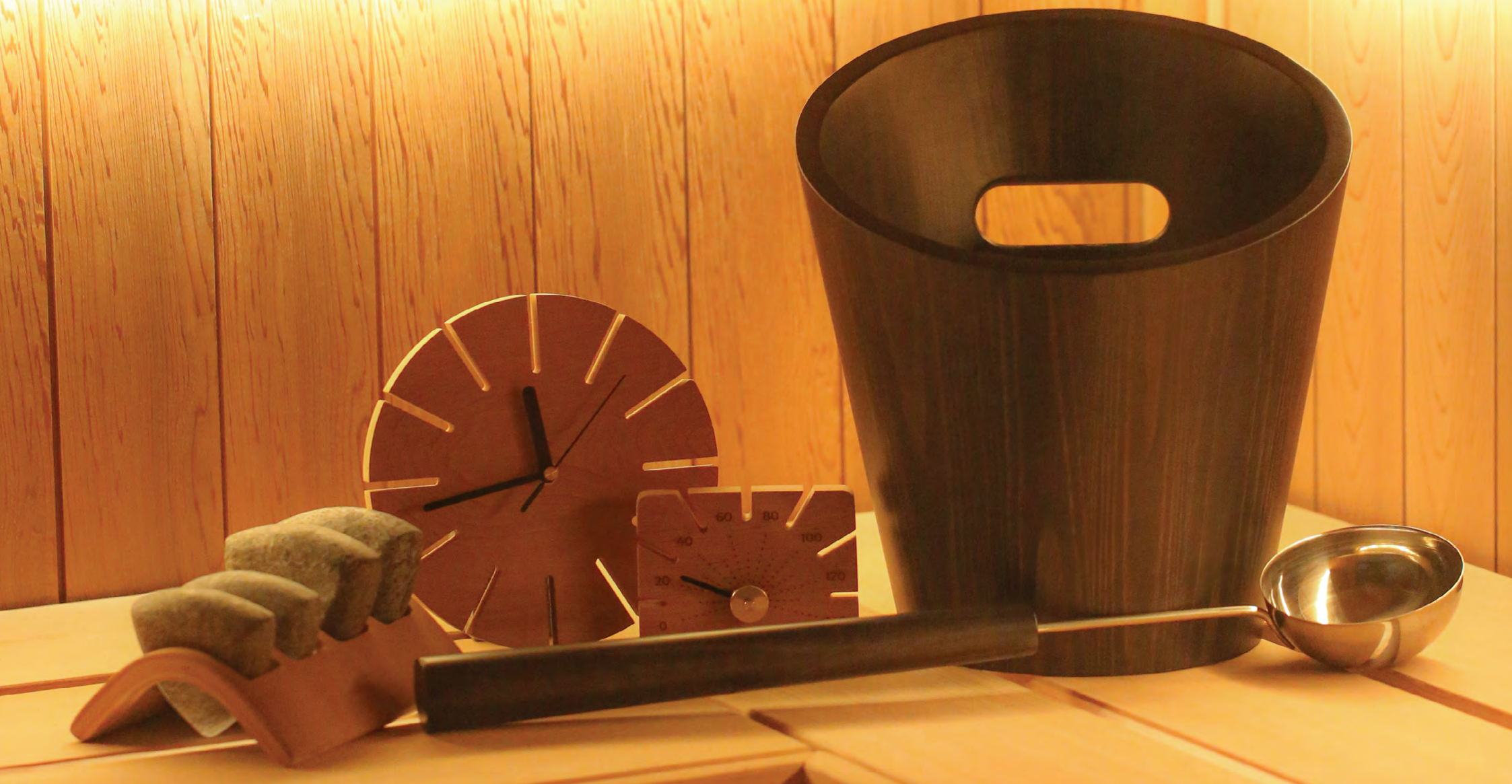



**Usva**  
code: 374-MD | MA  
capacity: 5L  
wood: Cedar | Aspen



**Stainless Pail with Curve Handle**  
code: 373-MA | MD  
capacity: 5L  
wood: Aspen | Cedar



**Stainless Pail with Wooden Handle**  
code: 375-MP | MA | MD  
capacity: 5L  
wood: Pine | Aspen | Cedar



**Kanto**  
code: 347-P | 347-WH | 347-BL  
capacity: 4L  
wood: Pine | White Pine | Black Pine



**Lovi**  
code: 346-P | 346-WH | 346-BL  
capacity: 4L  
wood: Pine | White Pine | Black Pine



**Dragon Pail**  
code: 342-D | 342-BL  
capacity: 4L | 9L  
wood: Cedar



**Wooden Pail Traditional**  
code: 300-TP | TA | TD  
capacity: 9L  
wood: Pine | Aspen | Cedar



**Wooden Pail Rattan**  
code: 341-P | A | D  
capacity: 4L  
wood: Pine | Aspen | Cedar



**Wooden Pail Rattan**  
code: 300-HP | HA | HD  
capacity: 9L  
wood: Pine | Aspen | Cedar



**Wooden Pail Rattan with Stainless Insert**  
code: 371-MP | MA | MD  
capacity: 5L  
wood: Pine | Aspen | Cedar



**Wooden Pail Classic**  
code: 340-P | A | D  
capacity: 4L  
wood: Pine | Aspen | Cedar



**Steamwater Pail 4L**  
code: 342-BL-DRF | 342-D-DRF  
capacity: 4L  
wood: Black Pine | Cedar



**Steamwater Pail 9L**  
code: 300-BL-DRF | 300-D-DRF  
capacity: 9L  
wood: Black Pine | Cedar



**Wooden Pail 18L**  
code: 381-P | A | D  
capacity: 18L  
wood: Pine | Aspen | Cedar



**Wooden Cover for 381**  
code: 381-P-COV | A-COV | D-COV  
use: Cover for 381 pail  
wood: Pine | Aspen | Cedar



**Wooden Pail 28L**  
code: 391-P | A | D  
capacity: 28L  
wood: Pine | Aspen | Cedar



**Wooden Cover for 391**  
code: 391-P-COV | A-COV | D-COV  
use: Cover for 391 pail  
wood: Pine | Aspen | Cedar



**Wooden Pail 40L**  
code: 392-P | A | D  
capacity: 40L  
wood: Pine | Aspen | Cedar



**Wooden Cover for 392**  
code: 392-P-COV | A-COV | D-COV  
use: Cover for 392 pail  
wood: Pine | Aspen | Cedar

# PAIL Shower

The **pail shower** is with a rope on the lever, hose and float valve. Its arc shaped holder design gives more possibilities to place shower either on the ceiling or to the wall. Pail shower is suitable for indoor or outdoor use. The hose needs to be connected to a water inlet so when water is flushed out, the pail will automatically be refilled – a never ending pail shower!



## Pail Shower

code: 393-D | S | BL  
capacity: 18L  
wood: Cedar | Spruce | Black



Wall Installation



Ceiling Installation



# SAUNA ACCESSORIES



Wooden Ladle Classic 41cm

code: 440 | D  
size: 410mm  
wood: Basswood | Cedar



Wooden Ladle Classic 52cm

code: 443 | D  
size: 520mm  
wood: Basswood | Cedar



Wooden Ladle Classic 68cm

code: 444 | D  
size: 680mm  
wood: Basswood | Cedar



Stainless Ladle 400mm

code: 441-MP | MA | MD  
size: 400mm  
wood: Pine | Aspen | Cedar



Brushed Steel Ladle Usva

code: 442-MP | MA | MD  
size: 400mm  
wood: Pine | Aspen | Cedar

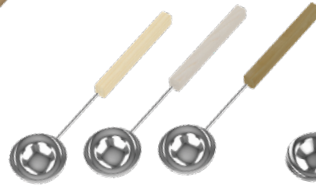

Stainless Ladle Siro 46.5cm

code: 445-MP | MA | MD  
size: 465mm  
wood: Pine | Aspen | Cedar



Stainless Ladle Siro 70.5cm

code: 446-MP | MA | MD  
size: 705mm  
wood: Pine | Aspen | Cedar



Stainless Ladle Huuru  
40cm

code: 452-MP | 452-MA | 452-MD  
size: 400mm  
wood: Pine | Aspen | Cedar



Stainless Ladle Curve

code: 453-MD | 453-MA  
size: 460mm  
wood: Cedar | Aspen



Dragon Ladle

code: 449-D | BL  
size: 498mm  
wood: Cedar | Black



Steamshot Ladle

code: 449-BL-DRF | 449-D-DRF  
size: 498mm  
wood: Black | Cedar



Kanto Ladle

code: 451-MBL | 451-MBL | 451-MP  
size:  
wood: Black | White | Pine



# THERMOMETERS & COMBINED METERS



**Thermometer Loisto Square**  
code: 108-TD  
size:  
wood: Cedar



**Thermometer Loisto Rounded**  
code: 109-TD  
size:  
wood: Cedar



**Thermometer Black Metal**  
code: 295-TMD  
size:  
material: Black Metal | Cedar



**Thermometer Kanto**  
code: 104-TD | 104-TWH | 104-TBL  
size: 125 x 125mm  
material: Cedar | White | Black



**Thermo-Hygrometer Black Metal**  
code: 295-THMD  
size:  
material: Cedar | Metal



**Thermometer Square**  
code: 223-TP | TA | TD  
size: 140 x 140mm  
wood: Pine | Aspen | Cedar



**Thermo-Hygrometer Rectangle**  
code: 224-THP | THA | THD  
size: 255 x 140mm  
wood: Pine | Aspen | Cedar



**Thermometer Cut Corner Square**  
code: 220-TP | TA | TD  
size: 140 x 140mm  
wood: Pine | Aspen | Cedar



**Thermo-Hygrometer Square**  
code: 225-THP | THA | THD  
size: 180 x 180mm  
wood: Pine | Aspen | Cedar



**Thermo-Hygrometer Curved Square**  
code: 285-THP | THA | THD  
size: 170 x 175mm  
wood: Pine | Aspen | Cedar



**Thermo-Hygrometer Basic Curved Rectangle**  
code: 271-THBP | THBA | THBD  
size: 225 x 140mm  
wood: Pine | Aspen | Cedar



**Thermo-Hygrometer Cut Corner Vertical Rectangle**  
code: 221-THP | THA | THD  
size: 225 x 140mm  
wood: Pine | Aspen | Cedar



**Thermo-Hygrometer Cut Corner Vertical Rectangle**  
code: 221-THVP | THVA | THVD  
size: 125 x 200mm  
wood: Pine | Aspen | Cedar



**Thermo-Hygrometer Rounded Rectangle**  
code: 222-THP | THA | THD  
size: 225 x 140mm  
wood: Pine | Aspen | Cedar



**Thermo-Hygrometer Curved Rectangle**  
code: 271-THP | THA | THD  
size: 225 x 140mm  
wood: Pine | Aspen | Cedar



**Thermo-Hygrometer Octagon**  
code: 241-THP | THA | THD  
size: 175 x 225mm  
wood: Pine | Aspen | Cedar



**Thermo-Hygrometer Drop**  
code: 251-THP | THA | THD  
size: 185 x 225mm  
wood: Pine | Aspen | Cedar



**Thermometer Accent Stone**  
code: 280-TRP | TRA | TRD  
size: 125 x 160mm  
wood: Pine | Aspen | Cedar



**Thermo-Hygrometer Accent Stone Vertical**  
code: 283-THVRP | THVRA | THVRD  
size: 155 x 255mm  
wood: Pine | Aspen | Cedar



**Thermometer Octagon**  
code: 240-TP | TA | TD  
size: 165 x 180mm  
wood: Pine | Aspen | Cedar



**Thermo-Hygrometer Circle**  
code: 231-THP | THA | THD  
size: Ø 185 x H 30mm  
wood: Pine | Aspen | Cedar



**Thermo-Hygrometer Accent Stone**  
code: 282-THRP | THRA | THRD  
size: 255 x 155mm  
wood: Pine | Aspen | Cedar



**Thermo-Hygrometer Accent Stone**  
code: 281-THRP | THRA | THRD  
size: 160 x 185mm  
wood: Pine | Aspen | Cedar



**Thermometer Drop**  
code: 250-TP | TA | TD  
size: 150 x 180mm  
wood: Pine | Aspen | Cedar



**Thermometer Circle**  
code: 230-TP | 230-TA | 230-TD  
size: Ø135 x H30mm  
wood: Pine | Aspen | Cedar



## CLOCKS & TIMERS



Loisto Clock  
Square

code: 534-D  
size:  
wood: Cedar



Loisto Clock  
Round

code: 535-D  
size:  
wood: Cedar



Wooden Pail  
Clock

code: 530-P | 530-A | 530-D  
size: Ø260 x H90mm  
wood: Pine | Aspen | Cedar



Wooden Pail  
Clock Small

code: 531-P | 531-A | 531-D  
size: Ø230 x H40mm  
wood: Pine | Aspen | Cedar



Sand Timer  
15min

code: 554-BL  
size:  
wood: Black Cedar



Sand Timer Tag  
15min

code: 550-P | 550-A | 550-D  
size: 65 x 340mm  
wood: Pine | Aspen | Cedar



Sand Timer  
15min with Stone

code: 550-RP | 550-RA | 550-RD  
size: 65 x 340mm  
wood: Pine | Aspen | Cedar



Sand Timer  
Classic 15min

code: 551-P | 551-A | 551-D  
size: 65 x 340mm  
wood: Pine | Aspen | Cedar



Sand Timer  
15min

code: 553-P | 553-A | 553-D  
size: 80 x 340mm  
wood: Pine | Aspen | Cedar



## HEADRESTS & BACKRESTS



Wave  
Wooden Backrest

code: 506-2-A | D  
size: 390 x 845mm  
wood: Aspen | Cedar



Wave  
Wooden Headrest

code: 515-A | D  
size: 190 x 480mm  
wood: Aspen | Cedar



Halu  
Wooden Headrest

code: 512-A | D  
size: 180 x 230mm  
wood: Aspen | Cedar



Halu  
Anti-theft Headrest

code: 513-A | D  
size: 190 x 480mm  
wood: Aspen | Cedar



Wooden  
Backrest

code: 516-P | A | D  
size: 396 x 515mm  
wood: Pine | Aspen | Cedar



Wooden  
Backrest

code: 514-A | D  
size: 346 x 888mm  
wood: Aspen | Cedar



## BENCHES



**Siro Sauna Bench**  
code: 528-D  
size: 440 x 290 x 400mm  
wood: Cedar



**Siro Sauna Bench**  
code: 529-D  
size: 750 x 290 x 400mm  
wood: Cedar



**Sauna Bench**  
code: 520-D  
size: 534 x 430 x 400mm  
wood: Cedar



**Sauna Bench**  
code: 521-D  
size: 870 x 430 x 400mm  
wood: Cedar



**Sauna Bench**  
code: 522-D  
size: 870 x 500 x 500mm  
wood: Cedar



**Sauna Bench**  
code: 523-D  
size: 1200 x 500 x 500mm  
wood: Cedar



**Sauna Bench 2-Steps**  
code: 524-D  
size: 530 x 780 x 850mm  
wood: Cedar



## WOODEN CLOTH HANGERS



**Wooden Cloth Hanger - 3 Holders**  
code: 582-P | A | D  
size: 42 x 240mm  
wood: Pine | Aspen | Cedar



**Wooden Cloth Hanger - 4 Holders**  
code: 586-P | A | D  
size: 42 x 340mm  
wood: Pine | Aspen | Cedar



**Wooden Cloth Hanger - 5 Holders**  
code: 583-P | A | D  
size: 42 x 440mm  
wood: Pine | Aspen | Cedar

## FLOOR MAT TILES



**Wooden Floor Mat Block**  
code: 595-D-BC | 595-A-BC | 595-GO-BC  
size: 285 x 285mm  
thickness: 22mm  
wood: Cedar | Aspen | Hardwood



**Wooden Floor Mat Corner Frame**  
code: 595-D-CNR | 595-A-CNR | 595-GO-CNR  
size: 390 x 115mm  
thickness: 22mm  
wood: Cedar | Aspen | Hardwood



**Wooden Floor Mat Middle Frame**  
code: 595-D-SID | 595-A-SID | 595-GO-SID  
size: 285 x 115mm  
thickness: 22mm  
wood: Cedar | Aspen | Hardwood

## COVERS FOR SAUNA LIGHT



**Wooden Light Cover Square**  
code: 910-SP | SA | SD  
size: 250 x 75mm  
wood: Pine | Aspen | Cedar



**Wooden Light Cover Square**  
code: 911-LP | LA | LD  
size: 250 x 135mm  
wood: Pine | Aspen | Cedar



**Wooden Light Cover Corner/Wall**  
code: 914-VP | VA | VD  
size: 150 x 110mm  
wood: Pine | Aspen | Cedar



**Wooden Light Cover Wave**  
code: 917-A | D  
size: 207 x 280mm  
wood: Aspen | Cedar

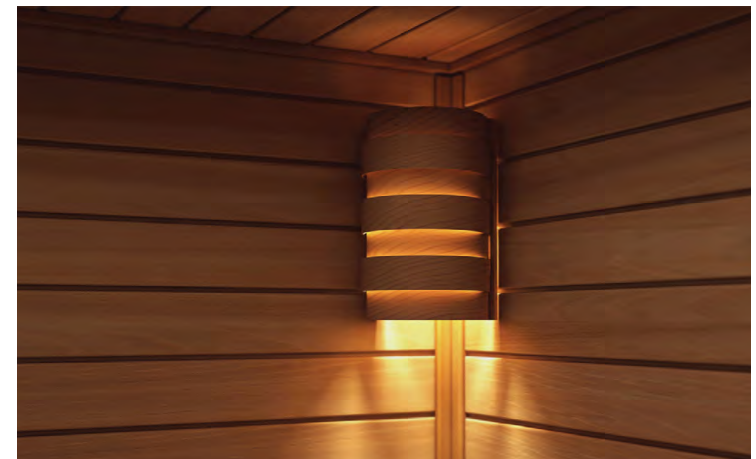



## DOOR HANDLES



**Wooden Arc Door Handle**  
code: 558-A | D  
size: 40 x 900mm  
wood: Aspen | Cedar

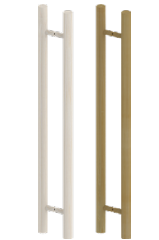

**Wooden Straight Door Handle**  
code: 559-A | D  
size: 36 x 900mm  
wood: Aspen | Cedar



**Wooden Straight Door Handle with metal Accent**  
code: 560-A | D | BL  
size: 155 x 900mm  
wood: Aspen | Cedar | Black



**Wooden Door Handle Small Round**  
code: 565-P | A | D  
size: Ø65 x W70mm  
wood: Pine | Aspen | Cedar



**Wooden Door Handle Big Round**  
code: 566-P | A | D  
size: Ø90 x W50mm  
wood: Pine | Aspen | Cedar



**Wooden Door Handle with Magnetic Lock**  
code: 568-P | A | D  
size: 260 x 45mm  
wood: Pine | Aspen | Cedar



**Door Hinge Round**  
code: 571  
size: 90 x 70mm  
material: Aluminum



**Door Lock Magnet Round, Heavy-Duty**  
code: 574  
material: Aluminum



## VENTILATIONS



**Ventilation Louver Square**  
code: 620-P | A | D  
size: 215 x 170mm  
wood: Pine | Aspen | Cedar



**Ventilation Louver Circle**  
code: 631-P | A | D  
size: Ø145mm  
wood: Pine | Aspen | Cedar  
ducting hole: 100mm



**Ventilation Louver Circle**  
code: 634-P | A | D  
size: Ø170mm  
wood: Pine | Aspen | Cedar  
ducting hole: 125mm



**Ventilation Louver Circle**  
code: 638-P | A | D  
size: Ø145mm  
wood: Pine | Aspen | Cedar  
ducting hole: 100mm



**Ventilation Louver Circle**  
code: 639-P | A | D  
size: Ø170mm  
wood: Pine | Aspen | Cedar  
ducting hole: 125mm



**Coaster / Bottle Opener**  
code: 581-P | A | D  
size: Ø80mm  
wood: Pine | Aspen | Cedar



**Sauna Signage**  
code: 950-P | A | D  
size: 150 x 80mm  
wood: Pine | Aspen | Cedar



**Moisture Paper**  
code: SP02-900  
size: 1,200mm x 77mm x 77mm



## DISPLAY STAND WALL



**Display Stand Wall 1**  
code: DP-15  
size: (W)1110 x (D)630 x (H)2000mm



**Display Stand Wall 2**  
code: DP-16  
size: (W)2300 x (D)630 x (H)2000mm



**Display Stand Wall 3**  
code: DP-17  
size: (W)3400 x (D)630 x (H)2000mm

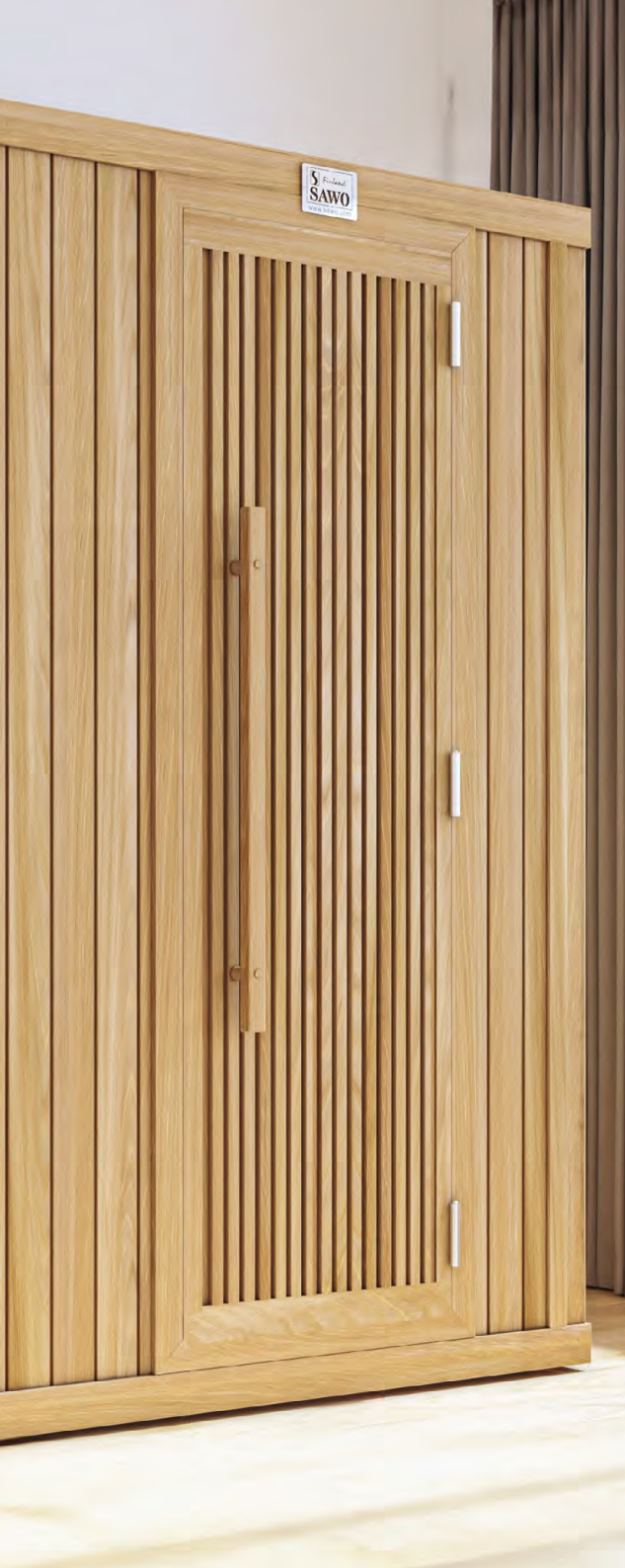

## DOOR SETS



**Wooden Stripe  
Sauna Door**  
code: 770-4SD-R | L  
Wooden size: 610 x 1935mm  
Frame size: 700 x 2040mm  
wood: Cedar



**Wooden Stripe  
Sauna Door**  
code: 771-4SD-R L  
Wooden size: 915 x 2015mm  
Frame size: 1005 x 2120mm  
wood: Cedar



**Wooden Reversible Sauna Door**  
code: 773-4SD | 734-4SD | 734-4SD  
Wooden size: 915 x 2015mm  
Frame size: 1005 x 2120mm  
wood: Cedar | Aspen | Spruce



**Wooden Reversible Sauna Door**  
code: 734-4SD | 734-4SD | 734-4SD  
Wooden size: 610 x 1935mm  
Frame size: 700 x 2040mm  
wood: Cedar | Aspen | Spruce



**Wooden Door with  
Clear Glass Window**  
code: 743-4SCD-R | L / 743-4SCA-R | L /  
743-4SCU-R | L  
Glass size: 600 x 1800mm  
Frame size: 690 x 1890mm  
wood: Cedar | Aspen | Spruce



**Wooden Door with  
Bronze Glass Window**  
code: 743-4SGD-R | L / 743-4SGA-R | L /  
743-4SGU-R | L  
Wooden size: 600 x 1800mm  
Frame size: 690 x 1890mm  
wood: Cedar | Aspen | Spruce



**Wooden Sauna Door w/ Window**  
code: 736-4SGD-R | L /  
736-4SGD-R | L  
Wooden size: 915 x 2015mm  
Frame size: 1005 x 2120mm  
wood: Aspen | Cedar



**Wooden Wide Clear Window  
Sauna Door**  
code: 739-3SCA-R | L /  
739-3SCD-R | L  
Frame size: 124 x 1003 x 2075mm  
wood: Aspen | Cedar



**Wooden Wide Bronze Window  
Sauna Door**  
code: 739-3SGA-R | L /  
739-3SGD-R | L  
Frame size: 124 x 1005 x 2075mm  
wood: Aspen | Cedar



Clear Glass Reversible Sauna Door

code: 730-4SCP | 730-4SCA | 730-4SCD  
 Glass size: 600 x 1800mm  
 Frame size: 690 x 1890mm  
 wood: Pine | Aspen | Cedar



Clear Glass Reversible Sauna Door

code: 731-4SCP | 731-4SCA | 731-4SCD  
 Glass size: 700 x 1800mm  
 Frame size: 790 x 1890mm  
 wood: Pine | Aspen | Cedar



Clear Glass Reversible Sauna Door  
 w/ Wooden Handle Arc

code: 741-4SCD-1 | 741-4SCA-1  
 Glass size: 600 x 1800mm  
 Frame size: 690 x 1890mm  
 wood: Aspen | Cedar



Clear Glass Reversible Sauna Door  
 w/ Wooden Handle Metal

code: 741-4SCD-3 | 741-4SCA-3  
 Glass size: 600 x 1800mm  
 Frame size: 690 x 1890mm  
 wood: Aspen | Cedar

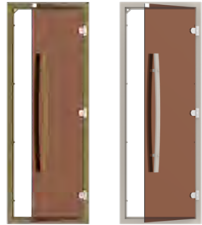

Bronze Glass Reversible Sauna Door  
 w/ Arc Handle

code: 741-4SGD-1 | 741-4SGA-1  
 Glass size: 600 x 1800mm  
 Frame size: 690 x 1890mm  
 wood: Cedar | Aspen



Bronze Glass Reversible Sauna Door  
 w/ Metallic Handle

code: 741-4SGD-3 | 741-4SGA-3  
 Glass size: 600 x 1800mm  
 Frame size: 690 x 1890mm  
 wood: Cedar | Aspen



Bronze Glass Reversible Sauna Door Standard

code: 730-4SGP | 730-4SGA | 730-4SGD  
 Glass size: 600 x 1800mm  
 Frame size: 690 x 1890mm  
 wood: Pine | Aspen | Cedar



Bronze Glass Reversible Sauna Door Standard

code: 731-4SGP | 731-4SGA | 731-4SGD  
 Glass size: 700 x 1800mm  
 Frame size: 790 x 1890mm  
 wood: Pine | Aspen | Cedar

Left-handed Bronze Glass Sauna Door  
 Finland w/ Arc Handle

code: 741-3SGD-L-1 | 741-3SGA-L-1  
 Glass size: 600 x 1800mm  
 Frame size: 690 x 1890mm  
 wood: Cedar | Aspen

Left-handed Bronze Glass Sauna Door  
 Finland w/ Metallic Handle

code: 741-3SGD-L-3 | 741-3SGA-L-3  
 Glass size: 600 x 1800mm  
 Frame size: 690 x 1890mm  
 wood: Cedar | Aspen

Left-handed Bronze Glass Sauna Door Finland

code: 730-3SGP-L | 730-3SGA-L | 730-3SGD-L  
 Glass size: 600 x 1800mm  
 Frame size: 690 x 1890mm  
 wood: Pine | Aspen | Cedar

Left-handed Bronze Glass Sauna Door Finland

code: 731-3SGP-L | 731-3SGA-L | 731-3SGD-L  
 Glass size: 700 x 1800mm  
 Frame size: 790 x 1890mm  
 wood: Pine | Aspen | Cedar

Right-handed Bronze Glass Sauna Door  
 Finland w/ Arc Handle

code: 741-3SGD-R-1 | 741-3SGA-R-1  
 Glass size: 600 x 1800mm  
 Frame size: 690 x 1890mm  
 wood: Cedar | Aspen

Right-handed Bronze Glass Sauna Door  
 Finland w/ Metallic Handle

code: 741-3SGD-R-3 | 741-3SGA-R-3  
 Glass size: 600 x 1800mm  
 Frame size: 690 x 1890mm  
 wood: Cedar | Aspen

Right-handed Bronze Glass Sauna Door Finland

code: 730-3SGP-R | 730-3SGA-R | 730-3SGD-R  
 Glass size: 600 x 1800mm  
 Frame size: 690 x 1890mm  
 wood: Pine | Aspen | Cedar

Right-handed Bronze Glass Sauna Door Finland

code: 731-3SGP-R | 731-3SGA-R | 731-3SGD-R  
 Glass size: 700 x 1800mm  
 Frame size: 790 x 1890mm  
 wood: Pine | Aspen | Cedar

# KIVISTONE®

**Kivistone** is a collection of beautiful products carved from Finnish soapstone. Each of these items are uniquely designed for house interiors, household use and for personal or corporate gifts. You will find a vast selection of interesting concepts and designs made of soapstone.

- » Coolers and cooler sets
- » Aroma cups and scent basins
- » Miscellaneous items



## SAUNA ACCESSORIES



**Wine Cooler Stone**  
code: R-93-D  
size: 235 x 60140mm  
material: Soapstone/Cedar



**Spa Stones Set**  
code: R-500-D  
size:  
material: Soapstone/Cedar



**Cooler (1 hole)**  
code: R-141  
size: 100 x 100 x 75mm  
weight: 1,3kG

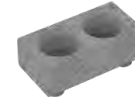

**Cooler (2 holes)**  
code: R-92  
size: 185 x 100 x 75mm  
weight: 4,1kG



**Cooler w/ 2 shot glasses**  
code: R-205  
size: 135 x 100 x 70mm  
weight: 1,8kG



**Cooler w/ 4 shot glasses**  
code: R-206  
size: 190 x 120 x 70mm  
weight: 2,3kG



**Luxury Aroma Cup (ø)50**  
code: R-160  
size: 50 x 50 x 50mm  
weight: 0,2kG



**Aroma Cup (ø)50**  
code: R-100  
size: 50 x 50 x 60mm  
weight: 0,3kG



**Aroma Spirit Cup**  
code: R-501  
size: 75 x 75 x 120mm  
weight: 0,7kG



**Scent Warmer**  
code: R-123  
size: 75 x 75 x 80mm  
weight: 0,7kG



**Candle Holder Tower**  
code: R-131  
size: 60 x 60 x 60mm  
weight: 0,6kG



**Candle Holder Tower**  
code: R-132  
size: 60 x 60 x 90mm  
weight: 0,9kG



**Candle Holder Tower**  
code: R-133  
size: 60 x 60 x 120mm  
weight: 1,2kG



**Tower Set 3**  
code: R-125  
size: 180 x 60 x 180mm  
weight: 1,8kG



**Candle Holder Straight**  
code: R-105  
size: 265 x 60 x 30mm  
weight: 1,3kG



**Plate w/ 3 shot glasses**  
code: R-151  
size: 240 x 170 x 35mm  
weight: 2,7kG



**Stone Plate Small**  
code: R-152  
size: 240 x 170 x 25mm  
weight: 2,8kG



**Stone Plate Large**  
code: R-153  
size: 305 x 200 x 15mm  
weight: 2,8kG



**Ashtray**  
code: R-407  
size: 60 x 50 x 60mm  
weight: 0,7kG

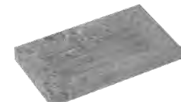

**Soap Holder**  
code: R-116  
size: 180 x 100 x 30mm  
weight: 0,9kG

# STEAM Sauna

Unwind stress with soothing clouds.

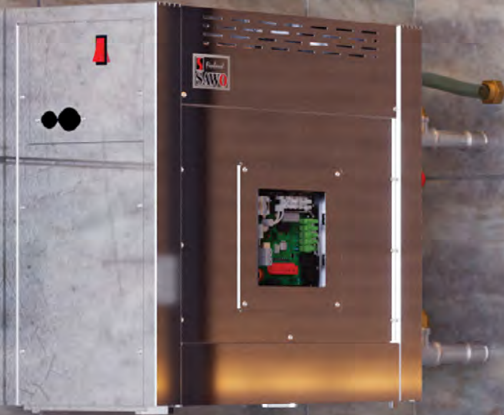



# STW-E Steam Generator

**STW-E Steam generators** are best for residential use. It has straight forward functions that is very easy to operate by switching on the control and adjusting the temperature knob. Now the updated design with removable side window for easier changing of settings on the board. It can be installed that the steam outlet be facing left or right at any convenient position.

SAWO steam generators can be tapped up to 5 series connections to have maximum power output using only 1 control. Maximum power output is 75kW.

ⓘ For more technical information, see page 85.



## 2 Heating Elements

- » Steam output up to 6,7kg/hr
- » Can be installed in either side
- » Own pipe for overpressure valve
- » Steam head included
- » 3kW - 5kW power



## 3 Heating Elements

- » Steam output up to 7,5kg/hr
- » Can be installed in either side
- » Own pipe for overpressure valve
- » Steam head included
- » 4,5kW - 7,5kW power



## 6 Heating Elements

- » Steam output up to 20kg/hr
- » Can be installed in either side
- » Own pipe for overpressure valve
- » Steam head included
- » 9kW - 15kW power

# STW Steam Generator

A more robust and heavy-duty performer **STW steam generator** is best for commercial use. Comes with unique cassette for heating elements for easy cleaning and replacement. Use the Aroma, Fan and dimmer features to customize the steam sauna experience to your liking. Demand button can be installed to release extra steam for 30 seconds. Troubleshooting becomes very handy as error codes are displayed on the controller screen. Now the updated design with removable side window for easier changing of settings on the board. These steam generators can be installed in any favorable left or right orientation. The autodrain is possible to be installed on the side or on the bottom.

SAWO steam generators can be tapped up to 5 series connections to have maximum power output using only 1 control. Maximum power output is 75kW.

! For more technical information, see page 85.



## 2 Heating Elements



- » Steam output up to 6,7kg/hr
- » Can be installed in either side
- » Own pipe for overpressure valve
- » Auto drain
- » Steam head included
- » Cassette type heating element setup for easy maintenance
- » 3kW - 5kW power
- » ¾" steam pipe
- » Stainless Touch & STW 2.0

## 3 Heating Elements



- » Steam output up to 7,5kg/hr
- » Can be installed in either side
- » Own pipe for overpressure valve
- » Auto drain
- » Steam head included
- » Cassette type heating element setup for easy maintenance
- » 4,5kW - 7,5kW power
- » ¾" steam pipe
- » Stainless Touch & STW 2.0

## 6 Heating Elements



- » Steam output up to 20kg/hr
- » Can be installed in either side
- » Own pipe for overpressure valve
- » Auto drain
- » Steam head included
- » Cassette type heating element setup for easy maintenance
- » 9kW - 15kW power
- » ¾" steam pipe
- » Stainless Touch & STW 2.0



# Technical DATA

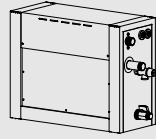

STW-E Steam Generator

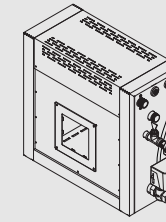

STW Steam Generator

## 2 Heating Elements

STEAM GENERATOR MODEL	kW	STEAM ROOM (m³)		SIZE OF STEAM GENERATOR			WEIGHT (KG)	CONTROL
		MIN	MAX	WIDTH	DEPTH (mm)	HEIGHT		
STW-E-30-1/2	3,0		3	555	275	465	16,5	STW-E 2.0
STW-E-35-1/2	3,5		3,5	555	275	465	16,5	STW-E 2.0
STW-E-40-1/2	4,0		4	555	275	465	16,5	STW-E 2.0
STW-E-45-1/2	4,5	2	5	555	275	465	16,5	STW-E 2.0
STW-E-50-1/2	5,0	2	6	555	275	465	16,5	STW-E 2.0

## 2 Heating Elements

STEAM GENERATOR MODEL	kW	STEAM ROOM (m³)		SIZE OF STEAM GENERATOR			WEIGHT (KG)	CONTROL
		MIN	MAX	WIDTH	DEPTH (mm)	HEIGHT		
STW-30-1/2	3,0		3	560	245	485	17	Stainless Touch   STW 2.0
STW-35-1/2	3,5		3,5	560	245	485	17	Stainless Touch   STW 2.0
STW-40-1/2	4,0		4	560	245	485	17	Stainless Touch   STW 2.0
STW-45-1/2	4,5	2	5	560	245	485	17	Stainless Touch   STW 2.0
STW-50-1/2	5,0	2	6	560	245	485	17	Stainless Touch   STW 2.0

## 3 Heating Elements

STEAM GENERATOR MODEL	kW	STEAM ROOM (m³)		SIZE OF STEAM GENERATOR			WEIGHT (KG)	CONTROL
		MIN	MAX	WIDTH	DEPTH (mm)	HEIGHT		
STW-E-45-C1/3	4,5	2	5	555	320	370	18	STW-E 2.0
STW-E-60-C1/3	6,0	3	10	555	320	370	18	STW-E 2.0
STW-E-75-C1/3	7,5	4	15	555	320	370	18	STW-E 2.0

## 3 Heating Elements

STEAM GENERATOR MODEL	kW	STEAM ROOM (m³)		SIZE OF STEAM GENERATOR			WEIGHT (KG)	CONTROL
		MIN	MAX	WIDTH	DEPTH (mm)	HEIGHT		
STW-45-3	4,5	2	5	560	280	485	19	Stainless Touch   STW 2.0
STW-45-C1/3	4,5	2	5	560	280	485	19	Stainless Touch   STW 2.0
STW-60-3	6,0	3	10	560	280	485	19	Stainless Touch   STW 2.0
STW-60-C1/3	6,0	3	10	560	280	485	19	Stainless Touch   STW 2.0
STW-75-3	7,5	4	15	560	280	485	19	Stainless Touch   STW 2.0
STW-75-C1/3	7,5	4	15	560	280	485	19	Stainless Touch   STW 2.0

## 6 Heating Elements

STEAM GENERATOR MODEL	kW	STEAM ROOM (m³)		SIZE OF STEAM GENERATOR			WEIGHT (KG)	CONTROL
		MIN	MAX	WIDTH	DEPTH (mm)	HEIGHT		
STW-E-90-C1/3	9,0	8	20	555	405	465	23	STW-E 2.0
STW-E-120-3	12,0	15	28	555	405	465	23	STW-E 2.0
STW-E-150-3	15,0	22	40	555	405	465	23	STW-E 2.0

## 6 Heating Elements

STEAM GENERATOR MODEL	kW	STEAM ROOM (m³)		SIZE OF STEAM GENERATOR			WEIGHT (KG)	CONTROL
		MIN	MAX	WIDTH	DEPTH (mm)	HEIGHT		
STW-90-3	9,0	8	20	560	375	485	23	Stainless Touch   STW 2.0
STW-90-C1/3	9,0	8	20	560	375	485	23	Stainless Touch   STW 2.0
STW-120-3	12,0	15	28	560	375	485	23	Stainless Touch   STW 2.0
STW-150-3	15,0	22	40	560	375	485	23	Stainless Touch   STW 2.0

## INCLUDED IN THE PACKAGE



Autodrain  
(Included for STN models only)



Aroma, Fan and Dimmer Functions  
(Optional features for STN models)



Temperature sensor with wire and sensor holder



Steam Head



7,5m RJ12 Cable  
7,5m RJ45 Cable

# STEAM GENERATOR Controls

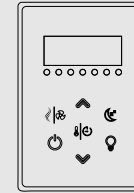

## Steam 2.0 (STP-INFACE-V2)

- » Thick stainless steel casing
- » LED digital display
- » Optional features: light dimmer, scent pump and fan
- » 7.5 meters RJ12 cable with connectors included

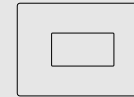

## Steam Stainless Touch (STP-INFACE-SST)

- » Thick stainless steel casing
- » Animated buttons
- » Compatible for automated household component
- » Emergency alarm provision
- » Standby mode to keep water warm until next session
- » Displays error code
- » Autodrain function
- » Key lock
- » Easy mode available
- » Date and time setup
- » Kilowatt usage counter
- » Decalcifying function
- » Heating Element fail detect
- » Blackout memory
- » Celsius or Fahrenheit temperature unit
- » Autolight
- » Autofan
- » LCD contrast adjustment
- » Optional scent pump, light dimmer and fan
- » Temperature sensor with wire
- » Optional interface holder
- » 7.5 meters RJ12 cable with connectors included

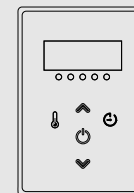

## Steam STE (STE-INFACE-V2)

- » Thick stainless steel casing
- » LED digital display
- » Optional features: light dimmer, scent pump and fan
- » 7.5 meters RJ12 cable with connectors included

OPTIONAL ITEMS



Aroma Pump



Demand Button



Steam Door  
code: ST-746  
size: 790 x 1890mm



Steam Door  
code: ST-749  
size: 900 x 2100mm

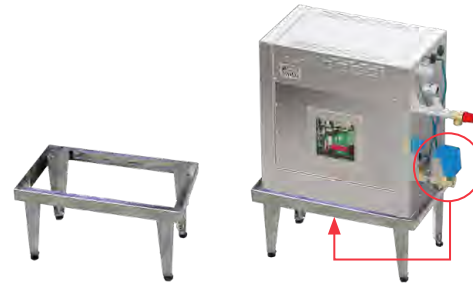

Installation Stand for STW  
code: STW-STAND

- » For easier installation of STW steam generator

VENTURI PIPE



Venturi Pipe L-shape



Venturi Pipe Straight

Venturi Pipe

- » Generate milder and softer steam
- » Create more steam clouds
- » Prevents hissing noise
- » Including steam head to spread the steam outburst
- » Thick stainless metal





[www.sawo.com](http://www.sawo.com)

 SAWO International

 SAWO - Sauna World

 SAWO Inc.

 SAWO Sauna World