



PRODUCT CATALOGUE

SAUNA & STEAM





SAW

Table of Contents

Finnish Sauna

Sauna Heaters

Tower Series	1	Stone Series	61
SAWO30 Heaters	2	Nimbus	62
Tower Heaters	10	Nimbus Combi	63
Aries Heaters	18	Culumbus	64
Cubos Heater	26	Heater Accessories	65
Phoenix Heater	29	Controls	66
Heaterking	31	Saunova Heater Controls	67
Fiberjungle	34	Innova Heater Controls	68
Floor Series	35	Sauna Accessories	71
Helius	36	Pails & Ladles	72
Taurus	38	Thermometers & Combined meters	75
Krios Floor	40	Clocks & Timers	76
Savonia	41	Benches, Hangers, Mats & Sauna Lights	77
Savonia Combi	42	Door Handles, & Miscellaneous Items	78
Nordex Floor	43	Door Sets	79
Nordex S	44	Kivistone	81
Nordex S Combi	45	Steam Sauna	82
Wall-Mounted Series	46	STE-W Steam Generator	83
Mini, Mini X & Mini Combi	47	STN-W Steam Generator	84
Scandia	49	Steam Generator Controls	86
Scandia Combi	50		
Krios	51		
Nordex	53		
Nordex Combi	54		
Nordex Mini	55		
Nordex Mini Combi	56		
Scandifire	58		
Minidragon	59		

A wooden sauna interior with a view of the ocean at sunset. The sauna has wooden slatted walls and a wooden bench. A metal handrail is visible in the foreground. The background shows a sunset over the ocean with palm tree silhouettes.

SAUNA Heaters

With over 30 years of experience on making sauna products, SAWO offers large variety of tower, stone, wall-mounted, floor and combi heaters.

Start by defining the size of your sauna, choose the right kW and controlling option. Anything else is up to your preference of what kind of *löyly* you are looking for and the style of the heater.

TOWER Series

SAWO Tower heater is best described as a *"sauna stone pillar."* Strong, stainless steel rings hold massive amounts of stones. The design is developed to produce steam from the lowest to the highest part of the sauna room.



SAWO30 Heaters

NEW!

SAWO30 Heaters are created to celebrate the 30 years journey of SAWO brand. Choose between Round, Corner or Wall model. Designed with precision and elegance, SAWO30 combines robust performance with a sleek, modern aesthetic, making it a centerpiece of any sauna. It's tall structure provides even heat from the bottom to the top.

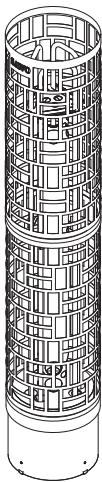

Round

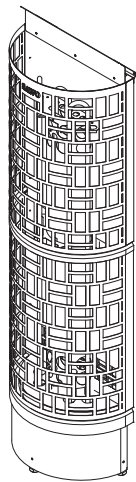

Wall

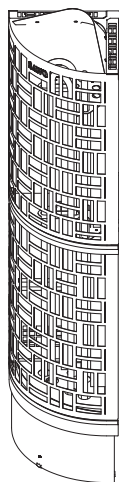

Corner





SAWO30 Round

- » Power Range: 4.5 – 24.0kW
- » Available controlling Ni2, NS and NB
- » Sauna Experience: Mild smooth heat, Humid
- » Casing in stainless or black steel
- » Easier loading of stones with separating middle part.
- » Removable stone spacer, choose between faster heating time and hotter heat or slower, milder heat.
- » Optional heater guard and integrated collar



SAWO30 Wall

- » Power Range: 4.5 – 24.0kW
- » Available controlling Ni2, NS and NB
- » Sauna Experience: Mild smooth heat, Humid
- » Casing In stainless or black steel
- » Easier loading of stones with separating middle part.
- » Removable stone spacer, choose between faster heating time and hotter heat or slower, milder heat.
- » Optional heater guard and integrated collar



SAWO30 Corner

- » Power Range: 4.5 – 12.0kW
- » Available controlling Ni2, NS and NB
- » Sauna Experience: Mild smooth heat, Humid
- » Casing In stainless or black steel
- » Easier loading of stones with separating middle part.
- » Removable stone spacer, choose between faster heating time and hotter heat or slower, milder heat.
- » Optional heater guard and integrated collar

SAWO30 Round

NEW!

SAWO30 Round is a magnificent looking heater that is perfect to be placed in the middle of the sauna or embedded into benches.

The large amount of stones in the tall sleek body enables rich, steam-infused atmosphere with an ideal combination of steam and humidity.





SAWO30 Round (Ni2) SAWO30 Round Black (Ni2)

Ni2

HEATER MODEL	kW	SAUNA ROOM		SIZE OF HEATER			STONES		CONTROL	MINIMUM SAFETY DISTANCES	
		MIN (m²)	MAX	WIDTH (mm)	DEPTH (mm)	HEIGHT (mm)	Without Stone Spacer	With Stone Spacer		A	B
SW3-45Ni2-P-C SW3-45Ni2-BL-P-C	4,5	3	6	243	243	1305	80	60	Saunova 2.0	100	1900
SW3-60Ni2-P-C SW3-60Ni2-BL-P-C	6,0	5	8	243	243	1305	80	60	Saunova 2.0	100	1900
SW6-90Ni2-P-C SW6-90Ni2-BL-P-C	9,0	8	15	344	344	1305	160	105	Saunova 2.0	100	1900



SAWO30 Round (NS) SAWO30 Round Black (NS)

Separate Control

HEATER MODEL	kW	SAUNA ROOM		SIZE OF HEATER			STONES		CONTROL	MINIMUM SAFETY DISTANCES	
		MIN (m²)	MAX	WIDTH (mm)	DEPTH (mm)	HEIGHT (mm)	Without Stone Spacer	With Stone Spacer		A	B
SW3-45NS-P-C SW3-45NS-BL-P-C	4,5	3	6	243	243	1305	80	60	separate	100	1900
SW3-60NS-P-C SW3-60NS-BL-P-C	6,0	5	8	243	243	1305	80	60	separate	100	1900
SW6-90NS-P-C SW6-90NS-BL-P-C	9,0	8	15	344	344	1305	160	105	separate	100	1900
SW6-120NS-P SW6-120NS-BL-P	12,0	11	18	344	344	1305	160	100	separate	100	2100
SW12-180NS-P SW12-180NS-BL-P	18,0	18	30	514	514	1305	250	165	separate	100	2300
SW12-210NS-P SW12-210NS-BL-P	21,0	22	35	514	514	1305	250	165	separate	100	2300
SW12-240NS-P SW12-240NS-BL-P	24,0	24	40	514	514	1305	250	165	separate	100	2300



SAWO30 Round (NB) SAWO30 Round Black (NB)

Built-in Control

HEATER MODEL	kW	SAUNA ROOM		SIZE OF HEATER			STONES		CONTROL	MINIMUM SAFETY DISTANCES	
		MIN (m²)	MAX	WIDTH (mm)	DEPTH (mm)	HEIGHT (mm)	Without Stone Spacer	With Stone Spacer		A	B
SW3-45NB-P-C SW3-45NB-BL-P-C	4,5	3	6	243	243	1305	80	60	8+4h	100	1900
SW3-60NB-P-C SW3-60NB-BL-P-C	6,0	5	8	243	243	1305	80	60	8+4h	100	1900
SW6-90NB-P-C SW6-90NB-BL-P-C	9,0	8	15	540	540	1305	160	105	8+4h	100	1900

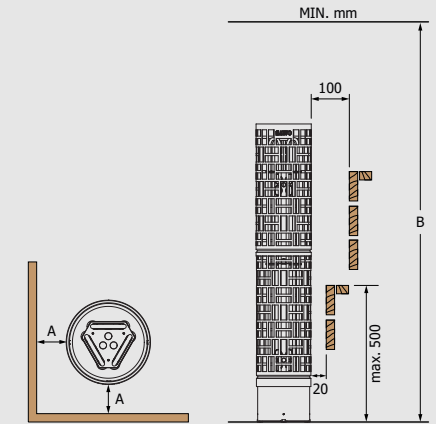

Minimum Safety Distances

Heater Accessories (Optional)

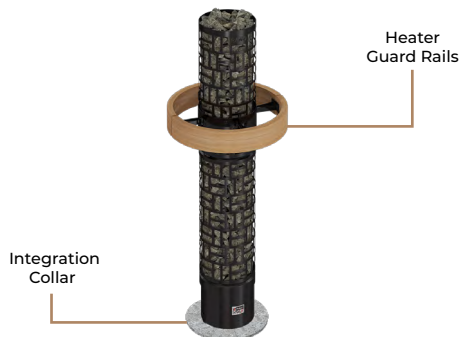

Integration Collars for Round



Stainless



Wooden
Cedar (D) & Aspen (A)



Soapstone

MODEL	SIZE OF COLLAR		
	WIDTH (mm)	DEPTH (mm)	HEIGHT (mm)
TH-COLLAR-ST2	470	470	70
TH-COLLAR-ST6	665	665	60
TH-COLLAR-ST12	830	830	70

MODEL	SIZE OF COLLAR		
	WIDTH (mm)	DEPTH (mm)	HEIGHT (mm)
TH-COLLAR-W2-D A	449	187	150
TH-COLLAR-W6-D A	547	215	150
TH-COLLAR-W12-D A	694	258	150

MODEL	SIZE OF COLLAR		
	WIDTH (mm)	DEPTH (mm)	HEIGHT (mm)
TH-COLLAR-S2	507	507	45
TH-COLLAR-S6	620	620	45
TH-COLLAR-S12	790	790	45

Heater Guards for Round



Wooden
Cedar (D) & Aspen (A)

MODEL	SIZE OF GUARD RAIL DIAMETER (mm)	HEATERS
SW-GUARD-W6-D A	620	SW6
SW-GUARD-W12-D A	790	SW12

SAWO30 Wall

NEW

SAWO30 Wall is perfect for saving space, with remaining very easy on the eyes.

The large amount of stones in the tall sleek body enables rich, steam-infused atmosphere with an ideal combination of steam and humidity.



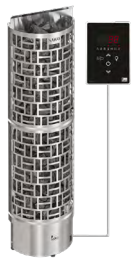

SAWO30 Wall (Ni2)



SAWO30 Wall Black (Ni2)



SAWO30 Wall (NS)



SAWO30 Wall Black (NS)



SAWO30 Wall (NB)



SAWO30 Wall Black (NB)

Ni2

HEATER MODEL	kW	SAUNA ROOM		SIZE OF HEATER			STONES		CONTROL	MINIMUM SAFETY DISTANCES	
		MIN	MAX	WIDTH	DEPTH	HEIGHT	Without Stone Spacer	With Stone Spacer		A	B
SW3-45Ni2-WL-P-C SW3-45Ni2-WL-BL-P-C	4,5	3	6	390	210	1375	80	60	Saunova 2.0	100	1900
SW3-60Ni2-WL-P-C SW3-60Ni2-WL-BL-P-C	6,0	5	8	390	210	1375	80	60	Saunova 2.0	100	1900
SW6-90Ni2-WL-P-C SW6-90Ni2-WL-BL-P-C	9,0	8	15	540	290	1375	120	90	Saunova 2.0	100	1900

Separate Control

HEATER MODEL	kW	SAUNA ROOM		SIZE OF HEATER			STONES		CONTROL	MINIMUM SAFETY DISTANCES	
		MIN	MAX	WIDTH	DEPTH	HEIGHT	Without Stone Spacer	With Stone Spacer		A	B
SW3-45NS-WL-P-C SW3-45NS-WL-BL-P-C	4,5	3	6	390	*210	1375	80	60	separate	100	1900
SW3-60NS-WL-P-C SW3-60NS-WL-BL-P-C	6,0	5	8	390	*210	1375	80	60	separate	100	1900
SW6-90NS-WL-P-C SW6-90NS-WL-BL-P-C	9,0	8	15	540	*290	1375	160	105	separate	100	1900
SW6-120NS-WL-P SW6-120NS-WL-BL-P	12,0	11	18	540	*290	1375	160	105	separate	100	2100
SW12-180NS-WL-P SW12-180NS-WL-BL-P	18,0	18	30	780	*430	1375	250	165	separate	100	2300
SW12-210NS-WL-P SW12-210NS-WL-BL-P	21,0	22	35	780	*430	1375	250	165	separate	100	2300
SW12-240NS-WL-P SW12-240NS-WL-BL-P	24,0	24	40	780	*430	1375	250	165	separate	100	2300

*Depth when installed to the wall.

Built-in Control

HEATER MODEL	kW	SAUNA ROOM		SIZE OF HEATER			STONES		CONTROL	MINIMUM SAFETY DISTANCES	
		MIN	MAX	WIDTH	DEPTH	HEIGHT	Without Stone Spacer	With Stone Spacer		A	B
SW3-45NB-WL-P-C SW3-45NB-WL-BL-P-C	4,5	3	6	390	210	1375	80	60	built-in	100	1900
SW3-60NB-WL-P-C SW3-60NB-WL-BL-P-C	6,0	5	8	390	210	1375	80	60	built-in	100	1900
SW6-90NB-WL-P-C SW6-90NB-WL-BL-P-C	9,0	8	15	540	290	1375	160	105	built-in	100	1900

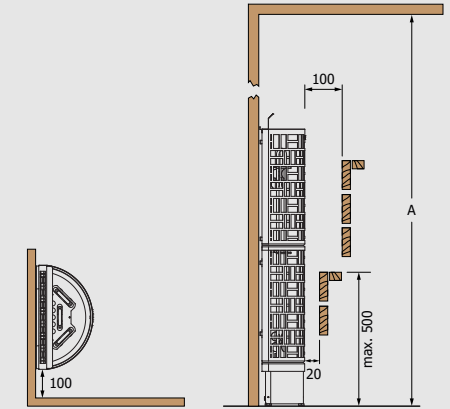

Minimum Safety Distances

Heater Accessories (Optional)

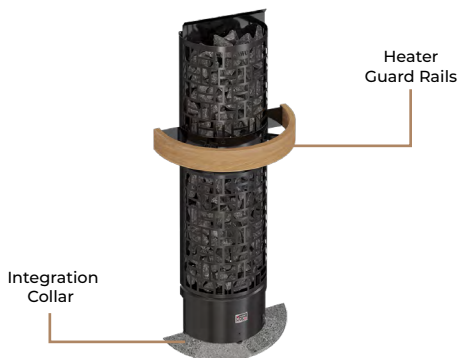

Heater Guard Rails

Integration Collar

Integration Collars for Wall



Stainless



Wooden Cedar (D) & Aspen (A)



Soapstone

MODEL	SIZE OF COLLAR		
	WIDTH	DEPTH	HEIGHT
TH-COLLAR-ST2-WL	665	365	70
TH-COLLAR-ST6-WL	640	640	42
TH-COLLAR-ST12-WL	1020	543	70

MODEL	SIZE OF COLLAR		
	WIDTH	DEPTH	HEIGHT
TH-COLLAR-W2-WL-D A	342	144	150
TH-COLLAR-W6-WL-D A	422	155	150
TH-COLLAR-W12-WL-D A	540	170	150

MODEL	SIZE OF COLLAR		
	WIDTH	DEPTH	HEIGHT
TH-COLLAR-S2-WL	270	150	140
TH-COLLAR-S6-WL	280	195	45
TH-COLLAR-S12-WL	416	238	138

Heater Guards for Wall



Wooden Cedar (D) & Aspen (A)

MODEL	SIZE OF GUARD RAIL	
	WIDTH	DEPTH
SW-GUARD-W2-WL-D A	615	330
SW-GUARD-W6-WL-D A	795	405
SW-GUARD-W12-WL-D A	1034	549

HEATERS
SW3
SW6
SW12



SAWO30 Corner

NEW!

Choose **SAWO30 Corner** to sauna layouts with tight on space.

The large amount of stones in the tall sleek body enables rich, steam-infused atmosphere with an ideal combination of steam and humidity.

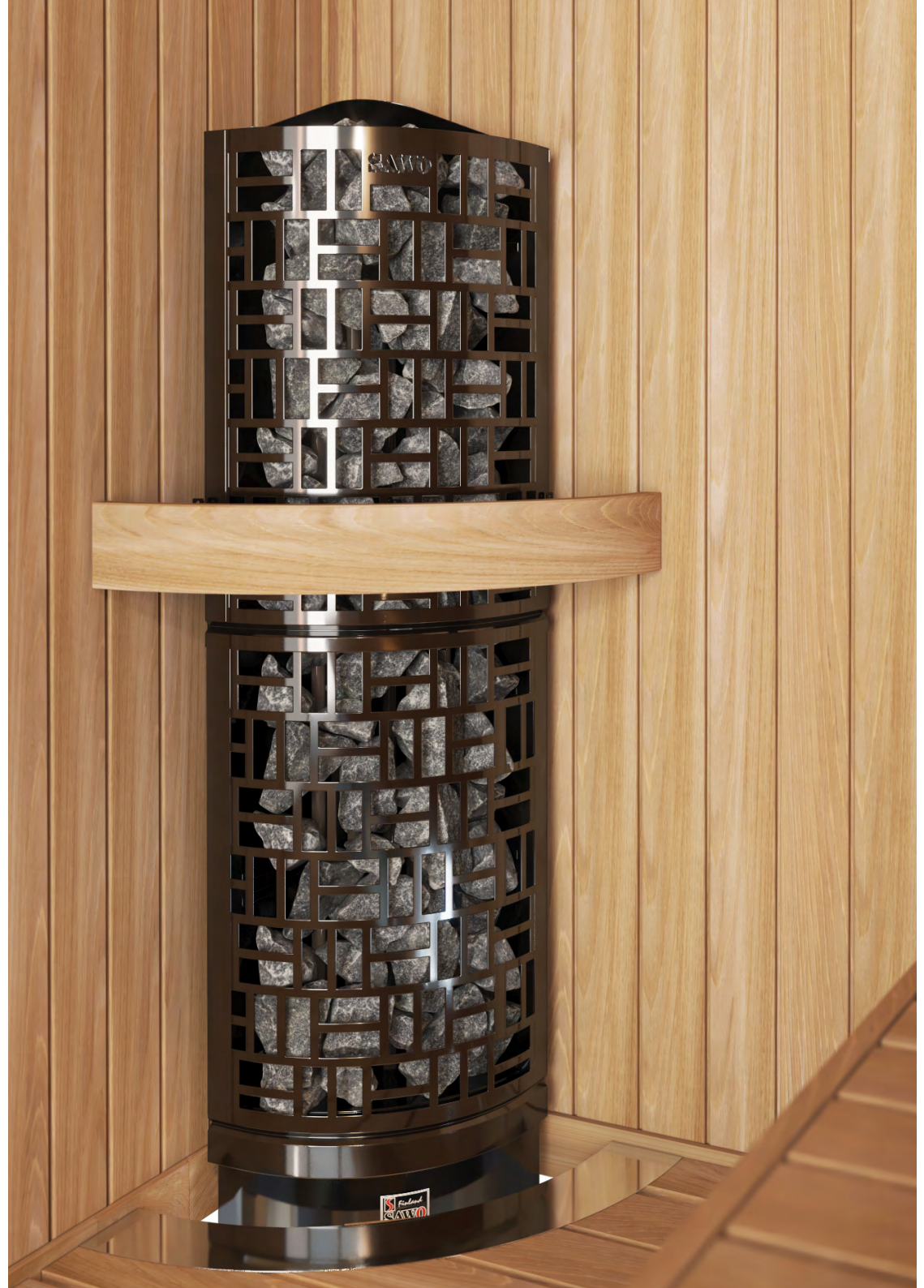



SAWO30 Corner (Ni2) SAWO30 Corner Black (Ni2)

Ni2

HEATER MODEL	kW	SAUNA ROOM		SIZE OF HEATER			STONES		CONTROL	MINIMUM SAFETY DISTANCES	
		MIN (m³)	MAX	WIDTH	DEPTH	HEIGHT	Without Stone Spacer (kg)	With Stone Spacer		A	B
SW3-45Ni2-CNR-P-C SW3-45Ni2-CNR-BL-P-C	4,5	3	6	295	*295	1375	70	45	Saunova 2.0	100	1900
SW3-60Ni2-CNR-P-C SW3-60Ni2-CNR-BL-P-C	6,0	5	8	295	*295	1375	70	45	Saunova 2.0	100	1900
SW6-90Ni2-CNR-P-C SW6-90Ni2-CNR-BL-P-C	9,0	8	15	410	*410	1375	160	100	Saunova 2.0	100	1900



SAWO30 Corner (NS) SAWO30 Corner Black (NS)

Separate Control

HEATER MODEL	kW	SAUNA ROOM		SIZE OF HEATER			STONES		CONTROL	MINIMUM SAFETY DISTANCES	
		MIN (m³)	MAX	WIDTH	DEPTH	HEIGHT	Without Stone Spacer (kg)	With Stone Spacer		A	B
SW3-45NS-CNR-P-C SW3-45NS-CNR-BL-P-C	4,5	3	6	295	*295	1375	70	45	separate	100	1900
SW3-60NS-CNR-P-C SW3-60NS-CNR-BL-P-C	6,0	5	8	295	*295	1375	70	45	separate	100	1900
SW6-90NS-CNR-P-C SW6-90NS-CNR-BL-P-C	9,0	8	15	410	*410	1375	160	80	separate	100	1900
SW6-120NS-CNR-P SW6-120NS-CNR-BL-P	12,0	11	18	410	*410	1375	160	80	separate	100	2100



SAWO30 Corner (NB) SAWO30 Corner Black (NB)

Built-in Control

HEATER MODEL	kW	SAUNA ROOM		SIZE OF HEATER			STONES		CONTROL	MINIMUM SAFETY DISTANCES	
		MIN (m³)	MAX	WIDTH	DEPTH	HEIGHT	Without Stone Spacer (kg)	With Stone Spacer		A	B
SW3-45NB-CNR-P-C SW3-45NB-CNR-BL-P-C	4,5	3	6	295	*295	1375	70	45	built-in	100	1900
SW3-60NB-CNR-P-C SW3-60NB-CNR-BL-P-C	6,0	5	8	295	*295	1375	70	45	built-in	100	1900
SW6-90NB-CNR-P-C SW6-90NB-CNR-BL-P-C	9,0	8	15	410	*410	1375	160	80	built-in	100	1900

*Depth when installed to the wall.

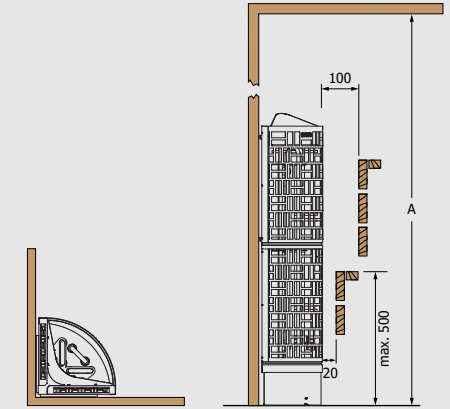

Minimum Safety Distances

Heater Accessories (Optional)

Integration Collars for Corner



Stainless



Wooden
Cedar (D) & Aspen (A)



Soapstone

Heater Guards for Corner



Wooden
Cedar (D) & Aspen (A)

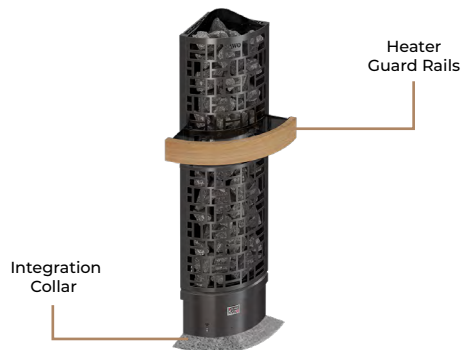

Heater Guard Rails

Integration Collar

MODEL	SIZE OF COLLAR		
	WIDTH (mm)	DEPTH (mm)	HEIGHT (mm)
TH-COLLAR-ST2-CNR	630	210	70
TH-COLLAR-ST4-CNR	675	210	65
TH-COLLAR-ST6-CNR	640	640	42

MODEL	SIZE OF COLLAR		
	WIDTH (mm)	DEPTH (mm)	HEIGHT (mm)
TH-COLLAR-W2-CNR-D A	230	122	150
TH-COLLAR-W4-CNR-D A	231	121	150
TH-COLLAR-W6-CNR-D A	261	123	150

MODEL	SIZE OF COLLAR		
	WIDTH (mm)	DEPTH (mm)	HEIGHT (mm)
TH-COLLAR-S2-CNR	240	130	150
TH-COLLAR-S4-CNR	205	150	135
TH-COLLAR-S6-CNR	210	185	45

MODEL	SIZE OF GUARD RAIL	
	WIDTH (mm)	DEPTH (mm)
SW-GUARD-W2-CNR-D A	580	420
SW-GUARD-W6-CNR-D A	750	530

HEATERS
SW3
SW6
SW12

TOWER Heaters

Tower heaters are developed to produce steam from the lowest to the highest part of the sauna, similar to smoke-sauna.

Tower heaters are equipped removable stone spacer, when in use you can enjoy more hotter temperature and save electricity through reduced heating time. The stone spacer improves air flow in the heater and helps to extend heating element life span when stones are not touching the elements.

When the stone spacer is not used, the large quantity of stones stores heat, releasing it steadily. The *löyly* is milder and softer.

Choose from Round, Wall or Corner model depending on your sauna layout.

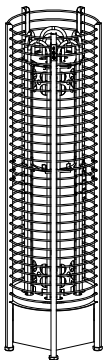

Round

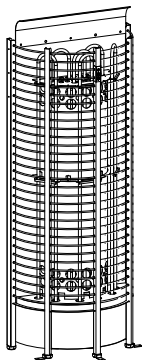

Wall

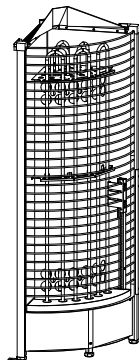

Corner





Tower ROUND

- » Power Range: 3.0 – 24.0kW
- » Available controlling Ni2, Ni, NS and NB
- » Sauna Experience: Mild smooth heat, Humid
- » Stainless steel casing
- » Moving steel rings for replacement of broken stones
- » Removable stone spacer, choose between faster heating time and hotter heat or slower, milder heat.
- » Adjustable legs
- » Optional Heater Guard and Integration Collar



Tower WALL

- » Power Range: 3.0 – 24.0kW
- » Available controlling Ni2, Ni, NS and NB
- » Sauna Experience: Mild smooth heat, Humid
- » Stainless steel casing
- » Moving rings for replacement of broken stones
- » Removable stone spacer, choose between faster heating time and hotter heat or slower, milder heat.
- » Adjustable legs
- » Optional Heater Guard and Integration Collar



Tower CORNER

- » Power Range: 3.0 – 12.0kW
- » Available controlling Ni2, Ni, NS and NB
- » Sauna Experience: Mild smooth heat, Humid
- » Stainless steel casing
- » Moving upper part for replacement of broken stones
- » Removable stone spacer, choose between faster heating time and hotter heat or slower, milder heat.
- » Adjustable legs
- » Optional Heater Guard and Integration Collar

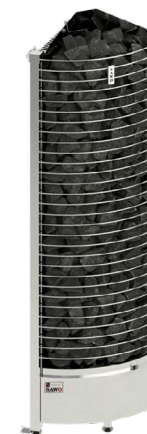

TOWER

Round

Tower Round is a timelessly elegant heater that will release long-lasting mild, steady and humid heat.

Round model is perfect to be placed in the middle of the sauna or embedded into benches. Suitable for small to extra-large saunas (2m³ - 40m³).





Tower Round (Ni2)

Tower Round (Ni)

Ni2 & Ni

HEATER MODEL	kW	SAUNA ROOM		SIZE OF HEATER			STONES		CONTROL	MINIMUM SAFETY DISTANCES	
		MIN	MAX	WIDTH	DEPTH	HEIGHT	Without Stone Spacer	With Stone Spacer		A	B
TH2-30Ni2	3,0	2	4	260	260	1300	70	60	Saunova 2.0	100	1900
TH3-35Ni2	3,5	3	6	260	260	1300	70	60	Saunova 2.0	100	1900
TH3-45Ni2	4,5	3	6	260	260	1300	70	60	Saunova 2.0	100	1900
TH3-60Ni2	6,0	5	8	260	260	1300	70	60	Saunova 2.0	150	1900
TH4-60Ni2	6,0	5	9	315	315	1300	105	90	Saunova 2.0	150	1900
TH5-80Ni2	8,0	8	14	315	315	1300	105	90	Saunova 2.0	150	1900
TH5-90Ni2	9,0	8	14	315	315	1300	105	90	Saunova 2.0	150	1900
TH6-80Ni2	8,0	7	14	365	365	1300	160	100	Saunova 2.0	150	1900
TH6-90Ni2	9,0	8	15	365	365	1300	160	100	Saunova 2.0	150	1900
TH6-105Ni2	10,5	9	16	365	365	1300	160	100	Innova	150	1900
TH6-120Ni2	12,0	11	18	365	365	1300	160	100	Innova	200	2100
TH9-105Ni2	10,5	10	16	450	450	1300	230	165	Innova	150	2100
TH9-120Ni2	12,0	11	20	450	450	1300	230	165	Innova	150	2100
TH9-150Ni2	15,0	14	25	450	450	1300	230	165	Innova	200	2100
TH9-180Ni2	18,0	18	28	450	450	1300	230	165	Innova	200	2100
TH12-150Ni2	15,0	15	26	545	545	1300	360	220	Innova	200	2300
TH12-180Ni2	18,0	18	30	545	545	1300	360	220	Innova	200	2300
TH12-210Ni2	21,0	22	35	545	545	1300	360	220	Innova	200	2300
TH12-240Ni2	24,0	24	40	545	545	1300	360	220	Innova	200	2300



Tower Round (NB)

Tower Round (NS)

Built-in Control / Separate Control

HEATER MODEL	kW	SAUNA ROOM		SIZE OF HEATER			STONES		CONTROL	MINIMUM SAFETY DISTANCES	
		MIN	MAX	WIDTH	DEPTH	HEIGHT	Without Stone Spacer	With Stone Spacer		A	B
TH2-30NB NS	3,0	2	4	260	260	1300	70	60	built-in separate	150 150	1900
TH3-35NB NS	3,5	3	6	260	260	1300	70	60	built-in separate	150 100	1900
TH3-45NB NS	4,5	3	6	260	260	1300	70	60	built-in separate	150 100	1900
TH3-60NB NS	6,0	5	8	260	260	1300	70	60	built-in separate	150 150	1900
TH4-60NB NS	6,0	5	9	315	315	1300	105	90	built-in separate	150 150	1900
TH5-80NB NS	8,0	7	13	315	315	1300	105	90	built-in separate	100 100	1900
TH5-90NS	9,0	8	14	315	315	1300	105	90	separate	150	1900
TH6-80NB NS	8,0	7	14	365	365	1300	160	100	built-in separate	100 100	1900
TH6-90NB NS	9,0	8	15	365	365	1300	160	100	built-in separate	100 100	1900
TH6-105NS	10,5	9	16	365	365	1300	160	100	separate	150	1900
TH6-120NS	12,0	11	18	365	365	1300	160	100	separate	200	2100
TH9-105NS	10,5	10	16	450	450	1300	230	165	separate	150	2100
TH9-120NS	12,0	11	20	450	450	1300	230	165	separate	150	2100
TH9-150NS	15,0	14	25	450	450	1300	230	165	separate	200	2100
TH9-180NS	18,0	18	28	450	450	1300	230	165	separate	200	2100
TH12-150NS	15,0	15	26	545	545	1300	360	220	separate	200	2300
TH12-180NS	18,0	18	30	545	545	1300	360	220	separate	200	2300
TH12-210NS	21,0	22	35	545	545	1300	360	220	separate	200	2300
TH12-240NS	24,0	24	40	545	545	1300	360	220	separate	200	2300

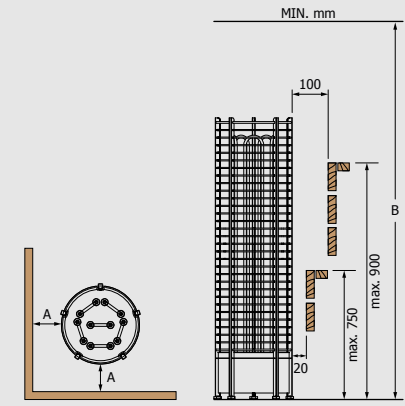

Minimum Safety Distances

Heater Accessories (Optional)

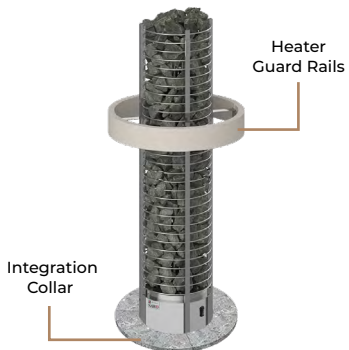

Stainless (for TH4 & TH5)



Stainless



Wooden Cedar (D) & Aspen (A)



Soapstone

Integration Collars for Round

MODEL	SIZE OF COLLAR
	WIDTH DEPTH HEIGHT (mm)
TH-COLLAR-V2-ST4	440 440 120

MODEL	SIZE OF COLLAR
	WIDTH DEPTH HEIGHT (mm)
TH-COLLAR-ST2	470 470 70
TH-COLLAR-ST4	545 545 55
TH-COLLAR-ST6	665 665 60
TH-COLLAR-ST9	720 720 42
TH-COLLAR-ST12	830 830 70

MODEL	SIZE OF COLLAR
	WIDTH DEPTH HEIGHT (mm)
TH-COLLAR-W2-D A	449 187 150
TH-COLLAR-W4-D A	495 200 150
TH-COLLAR-W6-D A	547 215 150
TH-COLLAR-W9-D A	608 233 150
TH-COLLAR-W12-D A	694 258 150

MODEL	SIZE OF COLLAR
	WIDTH DEPTH HEIGHT (mm)
TH-COLLAR-S2	507 507 45
TH-COLLAR-S4	560 560 45
TH-COLLAR-S6	620 620 45
TH-COLLAR-S9	690 690 45
TH-COLLAR-S12	790 790 45

Heater Guards for Round



Wooden Cedar (D) & Aspen (A)

MODEL	SIZE OF GUARD RAIL
	WIDTH DEPTH HEIGHT (mm)
TH-GUARD-W2-D A	510 270 210
TH-GUARD-W4-D A	570 290 200
TH-GUARD-W6-D A	625 625 110
TH-GUARD-W9-D A	710 375 208
TH-GUARD-W12-D A	810 420 220

MODEL
TH2 TH3
TH4 TH5
TH6
TH9
TH12

TOWER Wall

Tower Wall is a timelessly elegant heater that will release long-lasting mild, steady and humid heat.

Wall model will save space on the layout, with still being a show-stopper of the sauna. Suitable for small to extra-large saunas (2m³ - 40m³), to increase capacity to over 24kW you can always combine 2 Tower Walls back-to-back, which enables to grow power capacity as much as until 48kW.





Tower Wall (Ni2)

Tower Wall (Ni)

Ni2 & Ni

HEATER MODEL	KW	SAUNA ROOM (m³)		SIZE OF HEATER (mm)			STONES		CONTROL	MINIMUM SAFETY DISTANCES	
		MIN	MAX	WIDTH	DEPTH	HEIGHT	Without Stone Spacer (KG)	With Stone Spacer		A	B
TH2-30Ni2-WL	3,0	2	4	385	*230	1395	80	60	Saunova 2.0	100	1900
TH3-35Ni2-WL	3,5	3	6	385	*230	1395	80	60	Saunova 2.0	100	1900
TH3-45Ni2-WL	4,5	3	6	385	*230	1395	80	60	Saunova 2.0	100	1900
TH3-60Ni2-WL	6,0	5	8	385	*230	1395	80	60	Saunova 2.0	100	1900
TH4-60Ni2-WL	6,0	5	9	475	*250	1395	120	90	Saunova 2.0	100	1900
TH5-80Ni2-WL	8,0	8	14	475	*250	1395	120	90	Saunova 2.0	100	1900
TH5-90Ni2-WL	9,0	8	14	475	*250	1395	120	90	Saunova 2.0	100	1900
TH6-80Ni2-WL	8,0	7	14	550	*320	1395	160	105	Saunova 2.0	100	1900
TH6-90Ni2-WL	9,0	8	15	550	*320	1395	160	105	Saunova 2.0	100	1900
TH6-105Ni-WL	10,5	9	16	550	*320	1395	160	105	Innova	100	1900
TH6-120Ni-WL	12,0	11	18	550	*320	1395	160	105	Innova	100	2100
TH9-105Ni-WL	10,5	10	16	650	*355	1395	180	115	Innova	100	2100
TH9-120Ni-WL	12,0	11	20	650	*355	1395	180	115	Innova	100	2100
TH9-150Ni-WL	15,0	14	25	650	*355	1395	180	115	Innova	100	2100
TH12-150Ni-WL	15,0	15	26	790	*425	1395	250	165	Innova	100	2300
TH12-180Ni-WL	18,0	18	30	790	*425	1395	250	165	Innova	100	2300
TH12-210Ni-WL	21,0	22	35	790	*425	1395	250	165	Innova	100	2300
TH12-240Ni-WL	24,0	24	40	790	*425	1395	250	165	Innova	100	2300



Tower Wall (NiB)

Tower Wall (NiS)

Built-in Control / Separate Control

HEATER MODEL	KW	SAUNA ROOM (m³)		SIZE OF HEATER (mm)			STONES		CONTROL	MINIMUM SAFETY DISTANCES	
		MIN	MAX	WIDTH	DEPTH	HEIGHT	Without Stone Spacer (KG)	With Stone Spacer		A	B
TH2-30 NB NS-WL	3,0	2	4	385	*230	1395	80	60	built-in separate	100	1900
TH3-35 NB NS-WL	3,5	3	6	385	*230	1395	80	60	built-in separate	100	1900
TH3-45 NB NS-WL	4,5	3	6	385	*230	1395	80	60	built-in separate	100	1900
TH3-60 NB NS-WL	6,0	5	8	385	*230	1395	80	60	built-in separate	100	1900
TH4-60 NB NS-WL	6,0	5	9	475	*250	1395	120	90	built-in separate	100	1900
TH5-80 NB NS-WL	8,0	7	13	475	*250	1395	120	90	built-in separate	100	1900
TH5-90NS-WL	9,0	8	14	475	*250	1395	120	90	separate	100	1900
TH6-80 NB NS-WL	8,0	7	14	550	*320	1395	160	105	built-in separate	100	1900
TH6-90 NB NS-WL	9,0	8	15	550	*320	1395	160	105	built-in separate	100	1900
TH6-105NS-WL	10,5	9	16	550	*320	1395	160	105	separate	100	2100
TH6-120NS-WL	12,0	11	18	550	*320	1395	160	105	separate	100	2100
TH9-105NS-WL	10,5	10	16	650	*355	1395	180	115	separate	100	2100
TH9-120NS-WL	12,0	11	20	650	*355	1395	180	115	separate	100	2100
TH9-150NS-WL	15,0	14	25	650	*355	1395	180	115	separate	100	2100
TH9-180NS-WL	18,0	18	28	650	*355	1395	180	115	separate	100	2300
TH12-150NS-WL	15,0	15	26	790	*425	1395	250	165	separate	100	2300
TH12-180NS-WL	18,0	18	30	790	*425	1395	250	165	separate	100	2300
TH12-210NS-WL	21,0	22	35	790	*425	1395	250	165	separate	100	2300
TH12-240NS-WL	24,0	24	40	790	*425	1395	250	165	separate	100	2300

*Depth when installed to the wall.

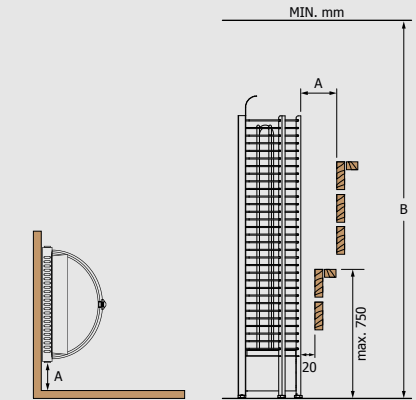

Minimum Safety Distances

Heater Accessories (Optional)

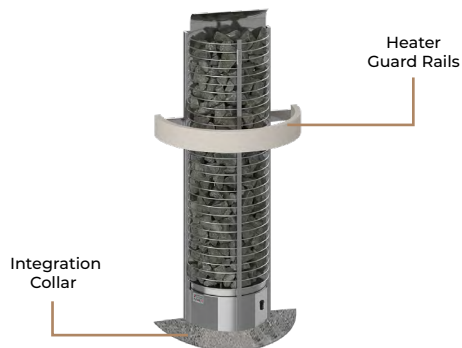

Integration Collars for Wall



MODEL	SIZE OF COLLAR (mm)	WIDTH	DEPTH	HEIGHT
TH-COLLAR-ST2-WL	665	365	70	
TH-COLLAR-ST4-WL	730	395	55	
TH-COLLAR-ST6-WL	640	640	42	
TH-COLLAR-ST9-WL	895	483	70	
TH-COLLAR-ST12-WL	1020	543	70	

MODEL	SIZE OF COLLAR (mm)	WIDTH	DEPTH	HEIGHT
TH-COLLAR-W2-WL-D A	342	144	150	
TH-COLLAR-W4-WL-D A	384	149	150	
TH-COLLAR-W6-WL-D A	422	155	150	
TH-COLLAR-W9-WL-D A	471	161	150	
TH-COLLAR-W12-WL-D A	540	170	150	

MODEL	SIZE OF COLLAR (mm)	WIDTH	DEPTH	HEIGHT
TH-COLLAR-S2-WL	270	150	140	
TH-COLLAR-S4-WL	342	185	125	
TH-COLLAR-S6-WL	280	195	45	
TH-COLLAR-S9-WL	285	225	45	
TH-COLLAR-S12-WL	416	238	138	

Heater Guards for Wall



MODEL	SIZE OF GUARD RAIL (mm)	WIDTH	DEPTH	HEIGHT
TH-GUARD-W2-WL-D A	645	355	95	
TH-GUARD-W4-WL-D A	721	391	90	
TH-GUARD-W6-WL-D A	810	444	110	
TH-GUARD-W9-WL-D A	904	476	110	
TH-GUARD-W12-WL-D A	810	420	220	

MODEL
TH2 TH3
TH4 TH5
TH6
TH9
TH12

TOWER Corner

Tower Corner is designed to fit into tight corners, this model maximizes your sauna layout without sacrificing style.

The Tower Corner will ensure a gentle, soothing warmth for a truly relaxing experience.

Suitable for small to large saunas (2m³ - 18m³).





Tower Round (Ni2)

Tower Round (Ni)



Tower Round (NB)

Tower Round (NS)

Ni2 & Ni

HEATER MODEL	KW	SAUNA ROOM (m²)		SIZE OF HEATER (mm)			STONES (kg)		CONTROL	MINIMUM SAFETY DISTANCES	
		MIN	MAX	WIDTH	DEPTH	HEIGHT	Without Stone Spacer	With Stone Spacer		A	B
TH2-30Ni2-CNR	3,0	2	4	300	*300	1380	70	45	Saunova	100	1900
TH3-35Ni2-CNR	3,5	3	6	300	*300	1380	70	45	Saunova	100	1900
TH3-45Ni2-CNR	4,5	3	6	300	*300	1380	70	45	Saunova	100	1900
TH3-60Ni2-CNR	6,0	5	8	300	*300	1380	70	45	Saunova	100	1900
TH4-60Ni2-CNR	6,0	5	9	355	*355	1380	105	70	Saunova	100	1900
TH5-80Ni2-CNR	8,0	7	13	355	*355	1380	105	70	Saunova	100	1900
TH5-90Ni2-CNR	9,0	8	14	355	*355	1380	105	70	Saunova	100	1900
TH6-80Ni2-CNR	8,0	7	14	415	*415	1380	160	80	Saunova	100	1900
TH6-90Ni2-CNR	9,0	8	15	415	*415	1380	160	80	Saunova	100	1900
TH6-105Ni2-CNR	10,5	9	16	415	*415	1380	160	80	Built-in Innova	100	1900
TH6-120Ni2-CNR	12,0	11	18	415	*415	1380	160	80	Built-in Innova	100	2100

Built-in Control

HEATER MODEL	KW	SAUNA ROOM (m²)		SIZE OF HEATER (mm)			STONES (kg)		CONTROL	MINIMUM SAFETY DISTANCES	
		MIN	MAX	WIDTH	DEPTH	HEIGHT	Without Stone Spacer	With Stone Spacer		A	B
TH2-30NB-CNR	3,0	2	4	300	*300	1380	70	45	built-in	125	1900
TH3-35NB-CNR	3,5	3	6	300	*300	1380	70	45	built-in	125	1900
TH3-45NB-CNR	4,5	3	6	300	*300	1380	70	45	built-in	125	1900
TH3-60NB-CNR	6,0	5	8	300	*300	1380	70	45	built-in	125	1900
TH4-60NB-CNR	6,0	5	9	355	*355	1380	105	70	built-in	125	1900
TH5-80NB-CNR	8,0	7	13	355	*355	1380	105	70	built-in	125	1900
TH6-80NB-CNR	8,0	7	14	415	*415	1380	160	80	built-in	125	1900
TH6-90NB-CNR	9,0	8	15	415	*415	1380	160	80	built-in	125	1900

Separate Control

HEATER MODEL	KW	SAUNA ROOM (m²)		SIZE OF HEATER (mm)			STONES (kg)		CONTROL	MINIMUM SAFETY DISTANCES	
		MIN	MAX	WIDTH	DEPTH	HEIGHT	Without Stone Spacer	With Stone Spacer		A	B
TH2-30NS-CNR	3,0	2	4	300	*300	1380	70	45	separate	100	1900
TH3-35NS-CNR	3,5	3	6	300	*300	1380	70	45	separate	100	1900
TH3-45NS-CNR	4,5	3	6	300	*300	1380	70	45	separate	100	1900
TH3-60NS-CNR	6,0	5	8	300	*300	1380	70	45	separate	100	1900
TH4-60NS-CNR	6,0	5	9	355	*355	1380	105	70	separate	100	1900
TH5-80NS-CNR	8,0	7	13	355	*355	1380	105	70	separate	100	1900
TH5-90NS-CNR	9,0	8	14	355	*355	1380	105	70	separate	100	1900
TH6-80NS-CNR	8,0	7	14	415	*415	1380	160	80	separate	100	1900
TH6-90NS-CNR	9,0	8	15	415	*415	1380	160	80	separate	100	1900
TH6-105NS-CNR	10,5	9	16	415	*415	1380	160	80	separate	100	1900
TH6-120NS-CNR	12,0	11	18	415	*415	1380	160	80	separate	100	2100

*Depth when installed to the wall.

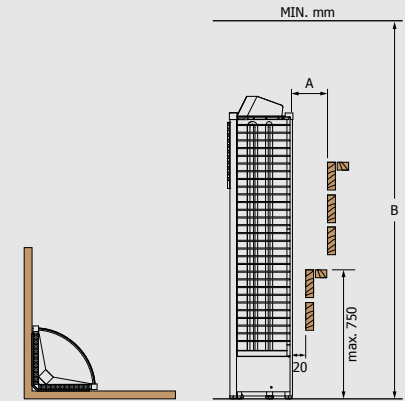

Minimum Safety Distances

Heater Accessories (Optional)

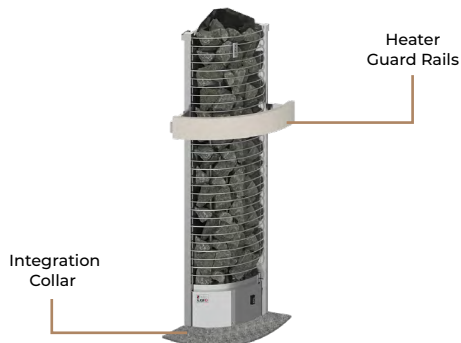

Heater Guard Rails

Integration Collar

Integration Collars for Corner



Stainless



Wooden Cedar (D) & Aspen (A)



Soapstone

MODEL	SIZE OF COLLAR (mm)		
	WIDTH	DEPTH	HEIGHT
TH-COLLAR-ST2-CNR	630	210	70
TH-COLLAR-ST4-CNR	675	210	65
TH-COLLAR-ST6-CNR	640	640	42

MODEL	SIZE OF COLLAR (mm)		
	WIDTH	DEPTH	HEIGHT
TH-COLLAR-W2-CNR-D A	230	122	150
TH-COLLAR-W4-CNR-D A	231	121	150
TH-COLLAR-W6-CNR-D A	261	123	150

MODEL	SIZE OF COLLAR (mm)		
	WIDTH	DEPTH	HEIGHT
TH-COLLAR-S2-CNR	240	130	150
TH-COLLAR-S4-CNR	205	150	135
TH-COLLAR-S6-CNR	210	185	45

Heater Guards for Corner



Wooden Cedar (D) & Aspen (A)

MODEL	SIZE OF GUARD RAIL (mm)		
	WIDTH	DEPTH	HEIGHT
TH-GUARD-W2-CNR-D A	595	237	90
TH-GUARD-W4-CNR-D A	670	252	90
TH-GUARD-W6-CNR-D A	755	200	120

MODEL
TH2 TH3
TH4 TH5
TH6

ARIES Heaters

Aries heaters are for those who appreciate simple structure and modern design. Choose from Round, Wall or Corner model depending on your sauna layout. Best for small and medium-sized saunas (3m³ - 29m³).

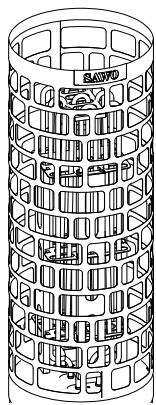

Round

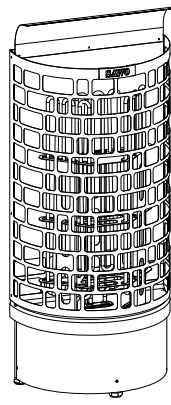

Wall



Corner





Aries ROUND

- » Power range 4.5 - 18.0kW
- » Available controlling Ni2, NS, NB
- » Sauna Experience: Medium heat, Humid
- » Built-in stone spacer
- » Stainless or black steel casing
- » Adjustable legs
- » Optional Heater guard and integration collar



Aries WALL

- » Power range 4.5 - 9.0kW
- » Available controlling Ni2, NS, NB
- » Sauna Experience: Medium heat, Humid
- » Built-in stone spacer
- » Stainless or black steel casing
- » Adjustable legs
- » Optional Heater guard and integration collar



Aries CORNER

- » Power range 4.5 - 9.0kW
- » Available controlling Ni2, NS, NB
- » Sauna Experience: Medium heat, Humid
- » Built-in stone spacer
- » Stainless or black steel casing
- » Adjustable legs
- » Optional Heater guard and integration collar

ARIES Round

Aries Round is a uniquely designed sauna heater that delivers consistent, medium heat. The stylish round shape makes it perfect for placement in the center of the sauna or embedded into benches.

Aries Round heater is a versatile option for saunas of all sizes, from small to large (3m³ - 29m³).



Technical DATA



Aries Round (Ni2)



Aries Round Black (Ni2)

Ni2

HEATER MODEL	KW	SAUNA ROOM		SIZE OF HEATER			STONES (KG)	MINIMUM SAFETY DISTANCES	
		MIN (m²)	MAX	WIDTH	DEPTH	HEIGHT		A	B
ARI3-45Ni2 ARI3-45Ni2-BL	4,5	3	6	300	300	930	60	100	1900
ARI3-60Ni2 ARI3-60Ni2-BL	6,0	5	8	300	300	930	60	100	1900
ARI3-75Ni2 ARI3-75Ni2-BL	7,5	7	12	300	300	930	60	100	1900
ARI3-90Ni2 ARI3-90Ni2-BL	9,0	8	14	300	300	930	60	100	1900



Aries Round (NS)



Aries Round Black (NS)

Separate Control

HEATER MODEL	KW	SAUNA ROOM		SIZE OF HEATER			STONES (KG)	MINIMUM SAFETY DISTANCES	
		MIN (m²)	MAX	WIDTH	DEPTH	HEIGHT		A	B
ARI3-45NS ARI3-45NS-BL	4,5	3	6	300	300	930	60	100	1900
ARI3-60NS ARI3-60NS-BL	6,0	5	8	300	300	930	60	100	1900
ARI3-75NS ARI3-75NS-BL	7,5	7	12	300	300	930	60	100	1900
ARI3-90NS ARI3-90NS-BL	9,0	8	14	300	300	930	60	100	1900
ARI6-90NS ARI6-90NS-BL	9,0	8	15	440	440	930	110	100	1900
ARI6-105NS ARI6-105NS-BL	10,5	9	16	440	440	930	110	100	1900
ARI6-120NS ARI6-120NS-BL	12,0	10	18	440	440	930	110	100	2100
ARI6-150NS ARI6-150NS-BL	15,0	13	24	440	440	930	110	100	2100
ARI6-180NS ARI6-180NS-BL	18,0	18	30	440	440	930	110	125	2100



Aries Round (NB)



Aries Round Black (NB)

Built-in Control

HEATER MODEL	KW	SAUNA ROOM		SIZE OF HEATER			STONES (KG)	MINIMUM SAFETY DISTANCES	
		MIN (m²)	MAX	WIDTH	DEPTH	HEIGHT		A	B
ARI3-45NB ARI3-45NB-BL	4,5	3	6	300	300	930	60	100	1900
ARI3-60NB ARI3-60NB-BL	6,0	5	8	300	300	930	60	100	1900
ARI3-75NB ARI3-75NB-BL	7,5	7	12	300	300	930	60	100	1900
ARI3-90NB ARI3-90NB-BL	9,0	8	14	300	300	930	60	100	1900
ARI6-90NB ARI6-90NB-BL	9,0	8	15	440	440	930	110	100	1900

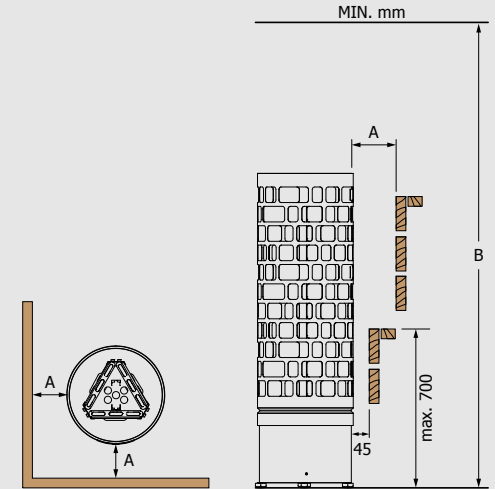

Minimum Safety Distances

Heater Accessories (Optional)

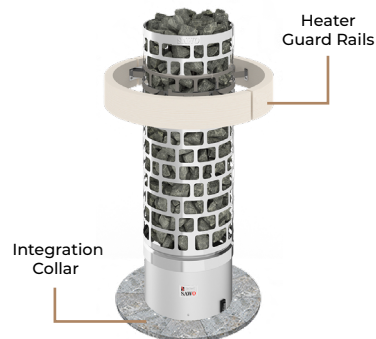

Stainless (for ARI3)



Stainless



Wooden Cedar (D) & Aspen (A)



Soapstone



Wooden Cedar (D) & Aspen (A)

MODEL	SIZE OF COLLAR		
	WIDTH (mm)	DEPTH (mm)	HEIGHT (mm)
TH-COLLAR-V2-ST4	440	440	120

MODEL	SIZE OF COLLAR		
	WIDTH (mm)	DEPTH (mm)	HEIGHT (mm)
TH-COLLAR-ST4	545	545	55
TH-COLLAR-ST6	665	665	60

MODEL	SIZE OF COLLAR		
	WIDTH (mm)	DEPTH (mm)	HEIGHT (mm)
TH-COLLAR-W4-D A	495	200	150
TH-COLLAR-W6-D A	547	215	150

MODEL	SIZE OF COLLAR		
	WIDTH (mm)	DEPTH (mm)	HEIGHT (mm)
TH-COLLAR-S4	560	560	45
TH-COLLAR-S6	620	620	45

MODEL	SIZE OF GUARD RAIL		
	WIDTH (mm)	DEPTH (mm)	HEIGHT (mm)
ARI-GUARD-W3-D A	585	570	120
ARI-GUARD-W6-D A	710	700	110

MODEL
ARI3
ARI6

ARIES Wall

Aries Wall is a space-saving, uniquely designed sauna heater that delivers consistent, medium heat. Its sleek design is perfect for installation next to the wall, freeing up valuable space in your sauna.

Ideal for small to medium-sized saunas (3m³ - 14m³), Aries Wall heater combines practicality with elegance.





Aries Wall (Ni2)

Aries Wall Black (Ni2)

Ni2

HEATER MODEL	kW	SAUNA ROOM (m ²)		SIZE OF HEATER (mm)			STONES (kg)	MINIMUM SAFETY DISTANCES (mm)	
		MIN	MAX	WIDTH	DEPTH	HEIGHT		A	B
ARI3-45Ni2-WL ARI3-45Ni2-WL-BL	4,5	3	6	415	*250	1030	65	100	1900
ARI3-60Ni2-WL ARI3-60Ni2-WL-BL	6,0	5	8	415	*250	1030	65	100	1900
ARI3-75Ni2-WL ARI3-75Ni2-WL-BL	7,5	7	12	415	*250	1030	65	100	1900
ARI3-90Ni2-WL ARI3-90Ni2-WL-BL	9,0	8	14	415	*250	1030	65	100	1900



Aries Wall (NS)

Aries Wall Black (NS)

Separate Control

HEATER MODEL	kW	SAUNA ROOM (m ²)		SIZE OF HEATER (mm)			STONES (kg)	MINIMUM SAFETY DISTANCES (mm)	
		MIN	MAX	WIDTH	DEPTH	HEIGHT		A	B
ARI3-45NS-WL ARI3-45NS-WL-BL	4,5	3	6	415	*250	1030	65	100	1900
ARI3-60NS-WL ARI3-60NS-WL-BL	6,0	5	8	415	*250	1030	65	100	1900
ARI3-75NS-WL ARI3-75NS-WL-BL	7,5	7	12	415	*250	1030	65	100	1900
ARI3-90NS-WL ARI3-90NS-WL-BL	9,0	8	14	415	*250	1030	65	100	1900



Aries Wall (NB)

Aries Wall Black (NB)

Built-in Control

HEATER MODEL	kW	SAUNA ROOM (m ²)		SIZE OF HEATER (mm)			STONES (kg)	MINIMUM SAFETY DISTANCES (mm)	
		MIN	MAX	WIDTH	DEPTH	HEIGHT		A	B
ARI3-45NB-WL ARI3-45NB-WL-BL	4,5	3	6	415	*250	1030	65	100	1900
ARI3-60NB-WL ARI3-60NB-WL-BL	6,0	5	8	415	*250	1030	65	100	1900
ARI3-75NB-WL ARI3-75NB-WL-BL	7,5	7	12	415	*250	1030	65	100	1900
ARI3-90NB-WL ARI3-90NB-WL-BL	9,0	8	14	415	*250	1030	65	100	1900

*Depth when installed to the wall.

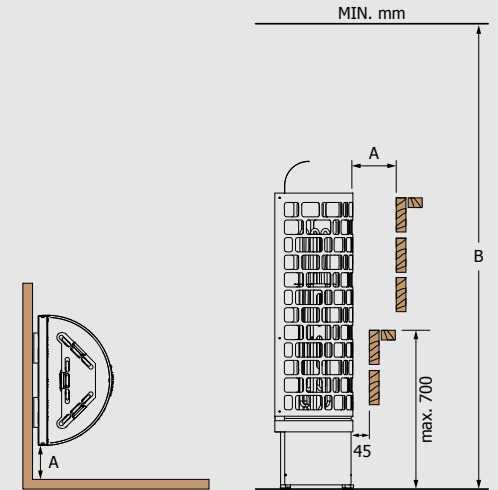

Minimum Safety Distances

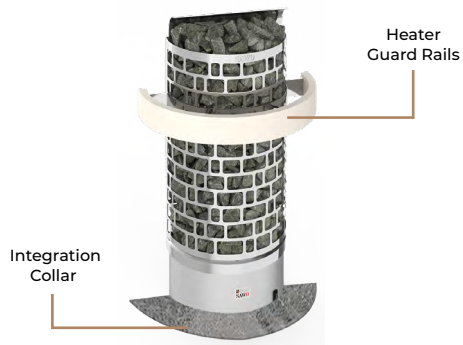

Heater Accessories (Optional)

Integration Collars for Wall



Stainless



Wooden Cedar (D) & Aspen (A)



Soapstone

Heater Guards for Wall

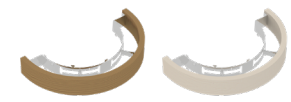

Wooden Cedar (D) & Aspen (A)

MODEL	SIZE OF COLLAR (mm)	WIDTH	DEPTH	HEIGHT
TH-COLLAR-ST4-WL	730	395	55	

MODEL	SIZE OF COLLAR (mm)	WIDTH	DEPTH	HEIGHT
TH-COLLAR-W4-WL-D A	384	149	150	

MODEL	SIZE OF COLLAR (mm)	WIDTH	DEPTH	HEIGHT
TH-COLLAR-S4-WL	342	185	125	

MODEL	SIZE OF GUARD RAIL (mm)	WIDTH	DEPTH	HEIGHT
ARI-GUARD-W3-WL-D A	665	380	120	

MODEL
ARI3

ARIES Corner

Aries Corner is a space-saving, uniquely designed sauna heater that delivers consistent, medium heat. Designed to fit snugly into the corner, this model maximizes your sauna layout without compromising style.

Ideal for small to medium-sized saunas (3m³ - 14m³), perfect for saunas with limited space.





Aries Corner (Ni2)



Aries Corner Black (Ni2)

Ni2

HEATER MODEL	kW	SAUNA ROOM		SIZE OF HEATER			STONES (kg)	MINIMUM SAFETY DISTANCES	
		MIN (m³)	MAX	WIDTH	DEPTH (mm)	HEIGHT		A	B
ARI3-45Ni2-CNR ARI3-45Ni2-CNR-BL	4,5	3	6	335	*335	1000	65	100	1900
ARI3-60Ni2-CNR ARI3-60Ni2-CNR-BL	6,0	5	8	335	*335	1000	65	100	1900
ARI3-75Ni2-CNR ARI3-75Ni2-CNR-BL	7,5	7	12	335	*335	1000	65	100	1900
ARI3-90Ni2-CNR ARI3-90Ni2-CNR-BL	9,0	8	14	335	*335	1000	65	100	1900



Aries Corner (NS)



Aries Corner Black (NS)

Separate Control

HEATER MODEL	kW	SAUNA ROOM		SIZE OF HEATER			STONES (kg)	MINIMUM SAFETY DISTANCES	
		MIN (m³)	MAX	WIDTH	DEPTH (mm)	HEIGHT		A	B
ARI3-45NS-CNR ARI3-45NS-CNR-BL	4,5	3	6	335	*335	1000	65	100	1900
ARI3-60NS-CNR ARI3-60NS-CNR-BL	6,0	5	8	335	*335	1000	65	100	1900
ARI3-75NS-CNR ARI3-75NS-CNR-BL	7,5	7	12	335	*335	1000	65	100	1900
ARI3-90NS-CNR ARI3-90NS-CNR-BL	9,0	8	14	335	*335	1000	65	100	1900



Aries Corner (NB)



Aries Corner Black (NB)

Built-in Control

HEATER MODEL	kW	SAUNA ROOM		SIZE OF HEATER			STONES (kg)	MINIMUM SAFETY DISTANCES	
		MIN (m³)	MAX	WIDTH	DEPTH (mm)	HEIGHT		A	B
ARI3-45NB-CNR ARI3-45NB-CNR-BL	4,5	3	6	335	*335	1000	65	100	1900
ARI3-60NB-CNR ARI3-60NB-CNR-BL	6,0	5	8	335	*335	1000	65	100	1900
ARI3-75NB-CNR ARI3-75NB-CNR-BL	7,5	7	12	335	*335	1000	65	100	1900
ARI3-90NB-CNR ARI3-90NB-CNR-BL	9,0	8	14	335	*335	1000	65	100	1900

*Depth when installed to the wall.

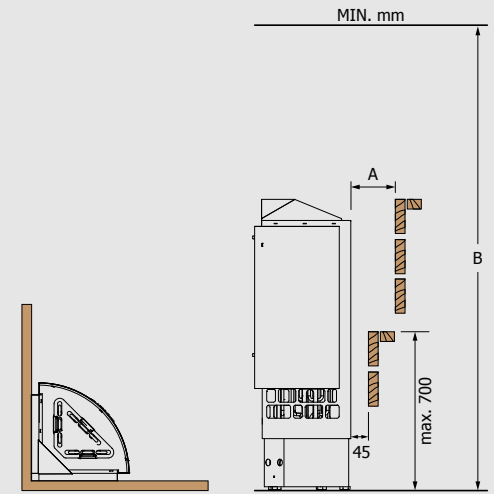

Minimum Safety Distances

Heater Accessories (Optional)

Integration Collars for Corner



Stainless



Wooden Cedar (D) & Aspen (A)



Soapstone

MODEL	SIZE OF COLLAR		
	WIDTH (mm)	DEPTH (mm)	HEIGHT (mm)
TH-COLLAR-ST4-CNR	675	210	65

MODEL	SIZE OF COLLAR		
	WIDTH (mm)	DEPTH (mm)	HEIGHT (mm)
TH-COLLAR-W4-CNR-D A	231	121	150

MODEL	SIZE OF COLLAR		
	WIDTH (mm)	DEPTH (mm)	HEIGHT (mm)
TH-COLLAR-S4-CNR	205	150	135

Corner Heater Guards



Wooden Cedar (D) & Aspen (A)

MODEL	SIZE OF GUARD RAIL		
	WIDTH (mm)	DEPTH (mm)	HEIGHT (mm)
ARI-GUARD-W3-D A	585	570	120

MODEL
ARI3

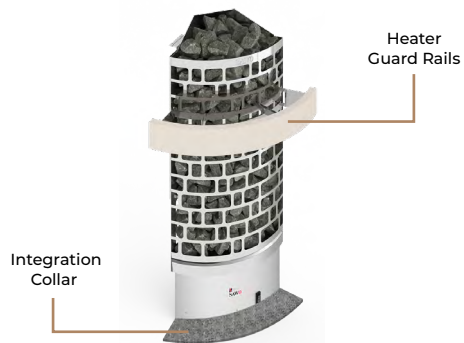

CUBOS Heater

Cubos is 3-in-1 heater! It can be placed in the middle, corner or wall of the sauna room. Additional protective covers will add support for wall and corner installation. This modern and versatile heater is one of a kind.

Cubos is also available with Saunova 2.0 control (Ni2). Ni2 heaters are effortless to install, easy and energy-efficient to use. Perfect choice for modern saunas.

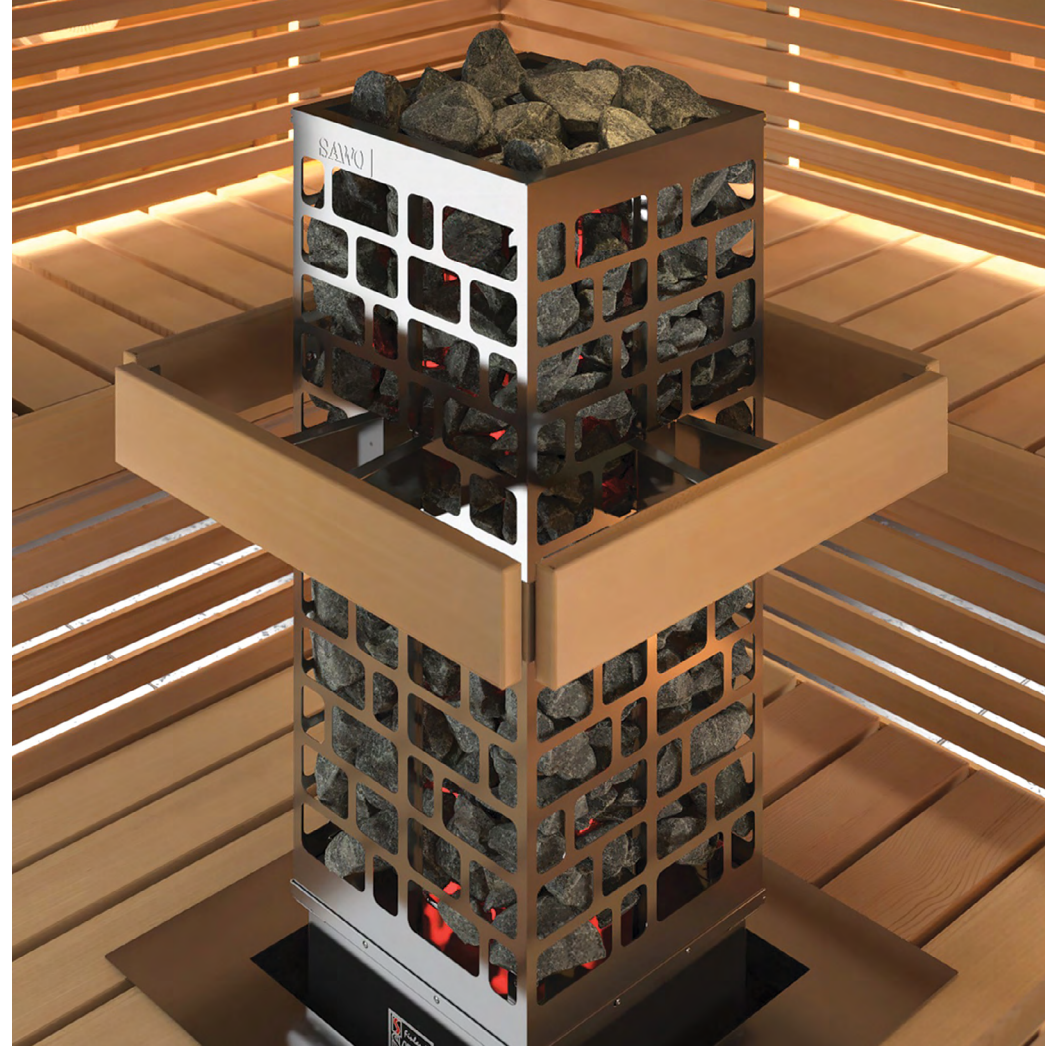

Saunova 2.0 Operated
(Ni2)



Separate
(NS)



Built-in Control
(NB)

Middle Installation

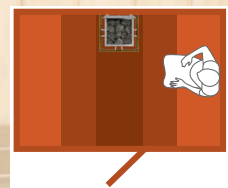
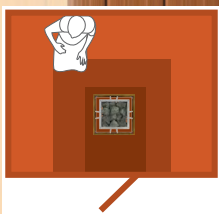

Wall Installation with Protective Cover

Cubos is a versatile heater with 3 different installation options. By adding Cubos Protective Cover, the cubos heater can be transformed to Wall or Corner heater.



Corner Installation with Protective Cover



Cubos

- » Power range 4.5 - 9.0kW
- » Available controlling Ni2, NS, NB
- » Sauna Experience: Medium heat, Humid
- » Built-in stone spacer
- » Stainless steel casing
- » Adjustable legs
- » Optional Heater guard and integration collar



Protective Cover Accessory

Wall Installation

Use Cubos Protective Cover for wall installation. Best for sauna designs with limited space. The set of the protective cover for wall includes covering sheet and a reflector that directs heat even to lowest parts of the sauna room.

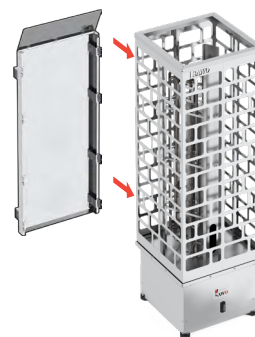

Wall Installation with Protective Cover

MODEL	SIZE OF COVER		
	WIDTH (mm)	DEPTH (mm)	HEIGHT (mm)
CUB-PROCOV-WL	660	300	65

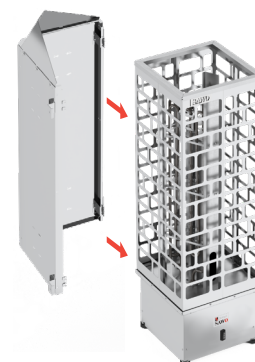

Corner Installation with Protective Cover

Corner Installation

Cubos quickly changes to corner model with Protective Cover for corner. Corner installation saves space and enables using different bench designs. The protective cover for corner set includes two pieces of covering sheet, a connection rod and a heat reflector.

MODEL	SIZE OF COVER		
	WIDTH (mm)	DEPTH (mm)	HEIGHT (mm)
CUB-PROCOV-CNR	660	300	100

Technical DATA

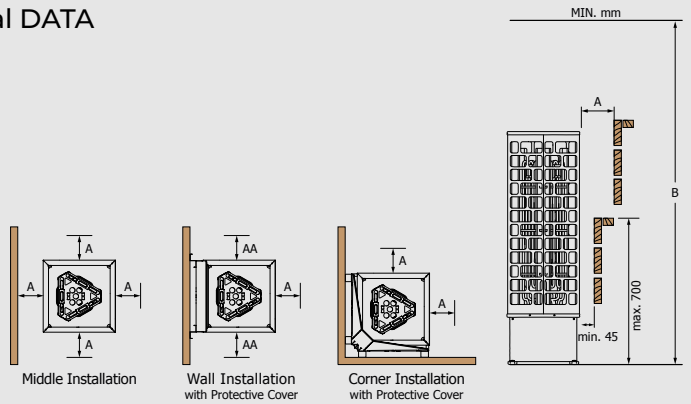

Minimum Safety Distances



Heater Accessories (Optional)

Cubos Heater Collars

Wooden Collar for CUB3 Middle Installation Cedar (D) & Aspen (A)

MODEL	SIZE OF COLLAR (mm)		
	WIDTH	DEPTH	HEIGHT
CUB-COLLAR-W3-D	550	110	200
CUB-COLLAR-W3-A	550	110	200

Wooden Collar for CUB3 Wall Installation Cedar (D) & Aspen (A)

MODEL	SIZE OF COLLAR (mm)		
	WIDTH	DEPTH	HEIGHT
CUB-COLLAR-W3-WL-D	462	395	45
CUB-COLLAR-W3-WL-A	462	395	45

Wooden Collar for CUB3 Corner Installation Cedar (D) & Aspen (A)

MODEL	SIZE OF COLLAR (mm)		
	WIDTH	DEPTH	HEIGHT
CUB-COLLAR-W3-CNR-D	485	110	110
CUB-COLLAR-W3-CNR-A	485	110	110

Stainless Steel Collar for CUB3 Middle Installation

MODEL	SIZE OF COLLAR (mm)		
	WIDTH	DEPTH	HEIGHT
CUB-COLLAR-ST3	545	70	550

Stainless Steel Collar for CUB3 Wall Installation

MODEL	SIZE OF COLLAR (mm)		
	WIDTH	DEPTH	HEIGHT
CUB-COLLAR-ST3-WL	545	70	490

Stainless Steel Collar for CUB3 Corner Installation

MODEL	SIZE OF COLLAR (mm)		
	WIDTH	DEPTH	HEIGHT
CUB-COLLAR-ST3-CNR	485	70	490

Soapstone Collar for CUB3 Middle Installation

MODEL	SIZE OF COLLAR (mm)		
	WIDTH	DEPTH	HEIGHT
CUB-COLLAR-S3	550	200	110

Soapstone Collar for CUB3 Wall Installation

MODEL	SIZE OF COLLAR (mm)		
	WIDTH	DEPTH	HEIGHT
CUB-COLLAR-S3-WL	550	150	150

Soapstone Collar for CUB3 Corner Installation

MODEL	SIZE OF COLLAR (mm)		
	WIDTH	DEPTH	HEIGHT
CUB-COLLAR-S3-CNR	482	110	110

Cubos Heater Guards

Wooden Heater Guard for CUB3 Middle Installation Cedar (D) & Aspen (A)

MODEL	SIZE OF GUARD RAIL (mm)		
	WIDTH	DEPTH	HEIGHT
CUB-GUARD-W3-D	530	150	170
CUB-GUARD-W3-A	530	150	170

Wooden Heater Guard for CUB3 Wall Installation Cedar (D) & Aspen (A)

MODEL	SIZE OF GUARD RAIL (mm)		
	WIDTH	DEPTH	HEIGHT
CUB-GUARD-W3-WL-D	550	150	150
CUB-GUARD-W3-WL-A	540	150	170

Wooden Heater Guard for CUB3 Corner Installation Cedar (D) & Aspen (A)

MODEL	SIZE OF GUARD RAIL (mm)		
	WIDTH	DEPTH	HEIGHT
CUB-GUARD-W3-CNR-D	458	150	150
CUB-GUARD-W3-CNR-A	458	150	170

Ni2

HEATER MODEL	kW	SAUNA ROOM		SIZE OF HEATER (mm)							STONES (KG)	CONTROL	MINIMUM SAFETY DISTANCES		
		MIN	MAX	MIDDLE		WALL		CORNER					A	AA	B
		(m³)	(m³)	WIDTH	DEPTH	WIDTH	DEPTH	WIDTH	DEPTH	HEIGHT					
CUB3-45Ni2	4,5	3	6	290	290	290	340	340	340	930	75	Saunova 2.0	100	100	1900
CUB3-60Ni2	6,0	5	9	290	290	290	340	340	340	930	75	Saunova 2.0	100	100	1900
CUB3-75Ni2	7,5	7	13	290	290	290	340	340	340	930	75	Saunova 2.0	100	135	1900
CUB3-90Ni2	9,0	8	14	290	290	290	340	340	340	930	75	Saunova 2.0	125	135	1900

Separate Control

HEATER MODEL	kW	SAUNA ROOM		SIZE OF HEATER (mm)							STONES (KG)	CONTROL	MINIMUM SAFETY DISTANCES		
		MIN	MAX	MIDDLE		WALL		CORNER					A	AA	B
		(m³)	(m³)	WIDTH	DEPTH	WIDTH	DEPTH	WIDTH	DEPTH	HEIGHT					
CUB3-45NS	4,5	3	6	290	290	290	340	340	340	930	75	separate	100	100	1900
CUB3-60NS	6,0	5	9	290	290	290	340	340	340	930	75	separate	100	100	1900
CUB3-75NS	7,5	7	13	290	290	290	340	340	340	930	75	separate	100	135	1900
CUB3-90NS	9,0	8	14	290	290	290	340	340	340	930	75	separate	125	135	1900

Built-in Control

HEATER MODEL	kW	SAUNA ROOM		SIZE OF HEATER (mm)							STONES (KG)	CONTROL	MINIMUM SAFETY DISTANCES		
		MIN	MAX	MIDDLE		WALL		CORNER					A	AA	B
		(m³)	(m³)	WIDTH	DEPTH	WIDTH	DEPTH	WIDTH	DEPTH	HEIGHT					
CUB3-45NB	4,5	3	6	290	290	290	340	340	340	930	75	built-in	100	100	1900
CUB3-60NB	6,0	5	9	290	290	290	340	340	340	930	75	built-in	100	100	1900
CUB3-75NB	7,5	7	13	290	290	290	340	340	340	930	75	built-in	100	135	1900
CUB3-90NB	9,0	8	14	290	290	290	340	340	340	930	75	built-in	125	135	1900

PHOENIX Heater

Rise from the ashes after a long day at work, and feel like a newborn with our **Phoenix heater**. The broadening shape, inspired by an Olympic torch, allows more stones to be placed in the top, ensuring creation of greater amount of pampering steam. Phoenix is suitable for small to large saunas (4.5m³ - 18.0m³).

- » Stainless tubes hold the stones
- » Stone spacer inside to prolong heating elements lifespan
- » Floor standing
- » Can fit from 85kg to 130kg of stones
- » 4,5kW - 18,0kW power
- » Separate, Ni2 control
- » Adjustable legs
- » Optional integration collar





Phoenix (Ni2)



Phoenix (NS)

Ni2

HEATER MODEL	kW	SAUNA ROOM		SIZE OF HEATER			STONES (KG)	CONTROL	MINIMUM SAFETY DISTANCES	
		MIN (m³)	MAX	WIDTH	DEPTH	HEIGHT			A	B
PNX3-45Ni2	4,5	3	6	375	340	1100	85	Saunova	100	1900
PNX3-60Ni2	6,0	5	9	375	340	1100	85	Saunova	125	1900
PNX3-75Ni2	7,5	7	13	375	340	1100	85	Saunova	125	1900
PNX3-90Ni2	9,0	8	14	375	340	1100	85	Saunova	150	1900
PNX6-90Ni2	9,0	8	15	525	475	1175	130	Saunova	150	1900

Separate Control

HEATER MODEL	kW	SAUNA ROOM		SIZE OF HEATER			STONES (KG)	CONTROL	MINIMUM SAFETY DISTANCES	
		MIN (m³)	MAX	WIDTH	DEPTH	HEIGHT			A	B
PNX3-45NS	4,5	3	6	375	340	1100	85	separate	100	1900
PNX3-60NS	6,0	5	9	375	340	1100	85	separate	125	1900
PNX3-75NS	7,5	7	13	375	340	1100	85	separate	125	1900
PNX3-90NS	9,0	8	14	375	340	1100	85	separate	150	1900
PNX6-90NS	9,0	8	15	525	475	1175	130	separate	150	1900
PNX6-105NS	10,5	9	16	525	475	1175	130	separate	150	1900
PNX6-120NS	12,0	11	18	525	475	1175	130	separate	150	2100
PNX6-150NS	15,0	14	25	525	475	1175	130	separate	150	2100
PNX6-180NS	18,0	18	28	525	475	1175	130	separate	175	2100

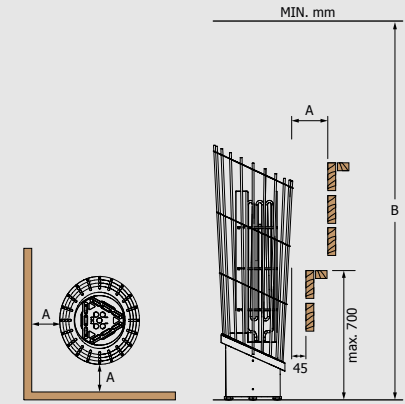

Minimum Safety Distances

Heater Accessories (Optional)



Stainless



Stainless Steel



Wooden
Cedar (D) & Aspen (A)



Soapstone

MODEL	SIZE OF COLLAR		
	WIDTH (mm)	DEPTH (mm)	HEIGHT (mm)
TH-COLLAR-V2-ST4	440	440	120

MODEL	SIZE OF COLLAR		
	WIDTH (mm)	DEPTH (mm)	HEIGHT (mm)
TH-COLLAR-ST4	545	545	55
TH-COLLAR-ST9	720	720	42

MODEL	SIZE OF COLLAR		
	WIDTH (mm)	DEPTH (mm)	HEIGHT (mm)
TH-COLLAR-W4-D A	495	200	150
TH-COLLAR-W9-D A	608	233	150

MODEL	SIZE OF COLLAR		
	WIDTH (mm)	DEPTH (mm)	HEIGHT (mm)
TH-COLLAR-S4	560	560	45
TH-COLLAR-S9	690	690	45

MODEL
PNX3
PNX6

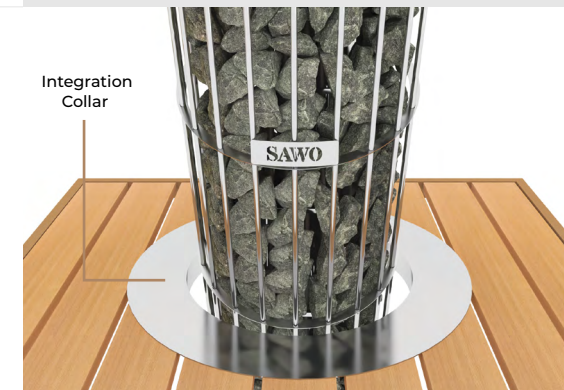

Heaterking

Heaterking heaters by *Stefan Lindfors* give king size heat in a design cover. Its long impressive, shape holds massive amount of stones and provides heat for all kind of sauna bathers. You can enjoy either smooth or sharp and dry heat by throwing water either to the bottom or top of the pillar. Unique stainless steel Junglfire-pattern design holds the stone pillar with style. Choose from Round, Wall or Corner model depending on your sauna layout. Heaterking has suitable kW from small to large saunas (2m³ - 40m³).



(Ni)



(NS)

Heaterking ROUND (Ni, NS)

- » Power range 3,0 – 24,0kW
- » Control: Separate
- » Casing with intricate junglfire pattern
- » Stone spacer inside to prolong heating elements lifespan
- » Can fit from 60kg to 360kg of stones
- » Round-type stainless steel casing
- » Optional Heater guard



(NS)

Heaterking WALL

- » Casing with intricate junglfire pattern
- » Stone spacer inside to prolong heating elements lifespan
- » Can fit from 60kg to 250kg of stones
- » 3,0kW - 24,0kW power
- » Wall type
- » Heat reflector included
- » Separate control



(NS)

Heaterking CORNER

- » Power range 3,5 – 12,0kW
- » Control: Separate
- » Casing with intricate junglfire pattern
- » Stone spacer inside to prolong heating elements lifespan
- » Can fit from 45kg to 160kg of stones
- » Corner-type stainless steel casing
- » Heat reflector included
- » Optional Heater guard

Technical DATA



Heaterking ROUND

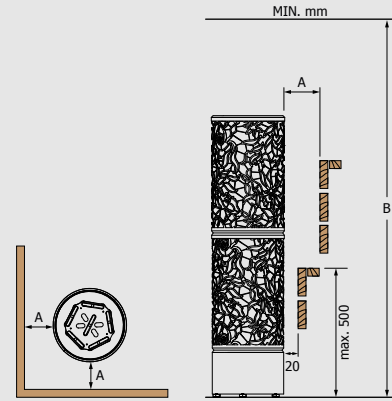

Minimum Safety Distances

Ni Version

HEATER MODEL	kW	SAUNA ROOM (m³)		SIZE OF HEATER (mm)			STONES (kg)		CONTROL	MINIMUM SAFETY DISTANCES (mm)	
		MIN	MAX	WIDTH	DEPTH	HEIGHT	Without Stone Spacer	With Stone Spacer		A	B
DRFT6-80Ni	8,0	7	14	355	355	1325	160	100	Built-in Innova	100	1900
DRFT6-90Ni	9,0	8	15	355	355	1325	160	100	Built-in Innova	100	1900
DRFT6-105Ni	10,5	9	16	355	355	1325	160	100	Built-in Innova	150	1900
DRFT6-120Ni	12,0	11	18	355	355	1325	160	100	Built-in Innova	200	2100
DRFT9-105Ni	10,5	10	16	425	425	1325	230	165	Built-in Innova	150	1900
DRFT9-120Ni	12,0	11	20	425	425	1325	230	165	Built-in Innova	150	2100
DRFT9-150Ni	15,0	14	25	425	425	1325	230	165	Built-in Innova	200	2100
DRFT9-180Ni	18,0	18	28	425	425	1325	230	165	Built-in Innova	200	2300
DRFT12-150Ni	15,0	15	26	525	525	1325	360	220	Built-in Innova	200	2300
DRFT12-180Ni	18,0	18	30	525	525	1325	360	220	Built-in Innova	200	2300
DRFT12-210Ni	21,0	22	35	525	525	1325	360	220	Built-in Innova	200	2300
DRFT12-240Ni	24,0	24	40	525	525	1325	360	220	Built-in Innova	200	2300

Separate Control

HEATER MODEL	kW	SAUNA ROOM (m³)		SIZE OF HEATER (mm)			STONES (kg)		CONTROL	MINIMUM SAFETY DISTANCES (mm)	
		MIN	MAX	WIDTH	DEPTH	HEIGHT	Without Stone Spacer	With Stone Spacer		A	B
DRFT2-30NS	3,0	2	4	250	250	1325	70	60	separate	150	1900
DRFT3-35NS	3,5	3	6	250	250	1325	70	60	separate	100	1900
DRFT3-45NS	4,5	3	6	250	250	1325	70	60	separate	100	1900
DRFT3-60NS	6,0	5	8	250	250	1325	70	60	separate	150	1900
DRFT4-60NS	6,0	5	9	295	295	1325	105	90	separate	100	1900
DRFT5-80NS	8,0	7	13	295	295	1325	105	90	separate	200	1900
DRFT5-90NS	9,0	8	14	295	295	1325	105	90	separate	200	1900
DRFT6-80NS	8,0	7	14	355	355	1325	160	100	separate	100	1900
DRFT6-90NS	9,0	8	15	355	355	1325	160	100	separate	100	1900
DRFT6-105NS	10,5	9	16	355	355	1325	160	100	separate	150	1900
DRFT6-120NS	12,0	11	18	355	355	1325	160	100	separate	200	2100
DRFT9-105NS	10,5	10	16	425	425	1325	230	165	separate	150	2100
DRFT9-120NS	12,0	11	20	425	425	1325	230	165	separate	150	2100
DRFT9-150NS	15,0	14	25	425	425	1325	230	165	separate	200	2100
DRFT9-180NS	18,0	18	28	425	425	1325	230	165	separate	200	2100
DRFT12-150NS	15,0	15	26	525	525	1325	360	220	separate	200	2300
DRFT12-180NS	18,0	18	30	525	525	1325	360	220	separate	200	2300
DRFT12-210NS	21,0	22	35	525	525	1325	360	220	separate	200	2300
DRFT12-240NS	24,0	24	40	525	525	1325	360	220	separate	200	2300

Heater Accessories (Optional)

Heaterking Round Heater Guards

Wooden Heater Guard for DRFT 2 & 3 H.E Round Cedar (D) & Aspen (A)



MODEL	SIZE OF GUARD RAIL (mm)		
	WIDTH	DEPTH	HEIGHT
DRFT-W2-D	517	264	200
DRFT-W2-A	517	264	200

Wooden Heater Guard for DRFT 4 & 5 H.E Round Cedar (D) & Aspen (A)



MODEL	SIZE OF GUARD RAIL (mm)		
	WIDTH	DEPTH	HEIGHT
DRFT-W4-D	570	290	200
DRFT-W4-A	570	290	200

Wooden Heater Guard for DRFT 6 H.E Round Cedar (D) & Aspen (A)



MODEL	SIZE OF GUARD RAIL (mm)		
	WIDTH	DEPTH	HEIGHT
DRFT-W6-D	595	304	120
DRFT-W6-A	595	304	120

Wooden Heater Guard for DRFT 9 H.E Round Cedar (D) & Aspen (A)



MODEL	SIZE OF GUARD RAIL (mm)		
	WIDTH	DEPTH	HEIGHT
DRFT-W9-D	700	365	200
DRFT-W9-A	700	365	200

Wooden Heater Guard for DRFT 12 H.E Round Cedar (D) & Aspen (A)



MODEL	SIZE OF GUARD RAIL (mm)		
	WIDTH	DEPTH	HEIGHT
DRFT-W12-D	800	411	200
DRFT-W12-A	800	411	200



Technical DATA



Heaterking WALL

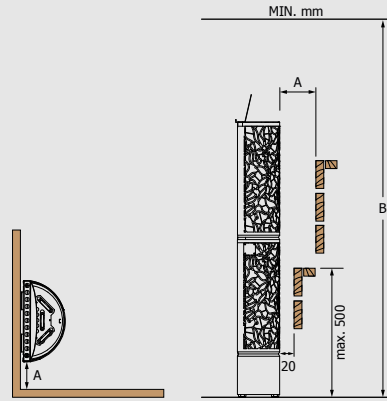

Minimum Safety Distances



Heaterking CORNER

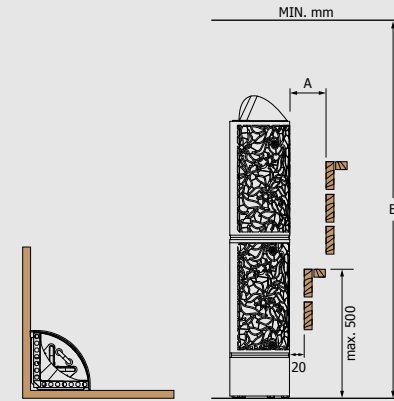

Minimum Safety Distances

Separate Control

HEATER MODEL	kW	SAUNA ROOM		SIZE OF HEATER			STONES		CONTROL	MINIMUM SAFETY DISTANCES	
		MIN (m³)	MAX (m³)	WIDTH (mm)	DEPTH (mm)	HEIGHT (mm)	Without Stone Spacer (kg)	With Stone Spacer (kg)		A	B
DRFT3-35NS-WL	3,5	3	6	395	*220	1450	80	60	separate	100	1900
DRFT3-45NS-WL	4,5	3	6	395	*220	1450	80	60	separate	100	1900
DRFT3-60NS-WL	6,0	5	8	395	*220	1450	80	60	separate	100	1900
DRFT6-80NS-WL	8,0	7	14	545	*300	1465	160	105	separate	100	1900
DRFT6-90NS-WL	9,0	8	15	545	*300	1465	160	105	separate	100	1900
DRFT6-105NS-WL	10,5	9	16	545	*300	1465	160	105	separate	100	1900
DRFT6-120NS-WL	12,0	11	18	545	*300	1465	160	105	separate	100	2100
DRFT9-105NS-WL	10,5	10	16	650	*350	1510	180	115	separate	100	2100
DRFT9-120NS-WL	12,0	11	20	650	*350	1510	180	115	separate	100	2100
DRFT9-150NS-WL	15,0	14	25	650	*350	1510	180	115	separate	100	2100
DRFT9-180NS-WL	18,0	18	28	650	*350	1510	180	115	separate	100	2100
DRFT12-150NS-WL	15,0	15	26	790	*420	1555	250	165	separate	100	2300
DRFT12-180NS-WL	18,0	18	30	790	*420	1555	250	165	separate	100	2300
DRFT12-210NS-WL	21,0	22	35	790	*420	1555	250	165	separate	100	2300
DRFT12-240NS-WL	24,0	24	40	790	*420	1555	250	165	separate	100	2300

*Depth when installed to the wall.

Separate Control

HEATER MODEL	kW	SAUNA ROOM		SIZE OF HEATER			STONES		CONTROL	MINIMUM SAFETY DISTANCES	
		MIN (m³)	MAX (m³)	WIDTH (mm)	DEPTH (mm)	HEIGHT (mm)	Without Stone Spacer (kg)	With Stone Spacer (kg)		A	B
DRFT3-35NS-CNR	3,5	3	6	300	*300	1395	70	45	separate	100	1900
DRFT3-45NS-CNR	4,5	3	6	300	*300	1395	70	45	separate	100	1900
DRFT3-60NS-CNR	6,0	5	8	300	*300	1395	70	45	separate	100	1900
DRFT6-80NS-CNR	8,0	7	14	410	*410	1415	160	80	separate	100	1900
DRFT6-90NS-CNR	9,0	8	15	410	*410	1415	160	80	separate	100	1900
DRFT6-105NS-CNR	10,5	9	16	410	*410	1415	160	80	separate	100	1900
DRFT6-120NS-CNR	12,0	11	18	410	*410	1415	160	80	separate	100	2100

*Depth when installed to the wall.



Fiberjungle

A long shape of **Fiberjungle** holds great amount of stones giving pleasant heat - Junglefire heat. This heater is fully coated with black colored velvet cool-to-touch fiber, with pattern designed by Stefan Lindfors. It is not only a eye-catcher, but also a safe heater. Ideal for placing center of the sauna room, as the coating makes sure no one burns their skin.



(NS)

- » Power range 4.5 - 9.0kW
- » Available controlling NS
- » Sauna Experience: Mild smooth heat

Technical DATA



Fiberjungle

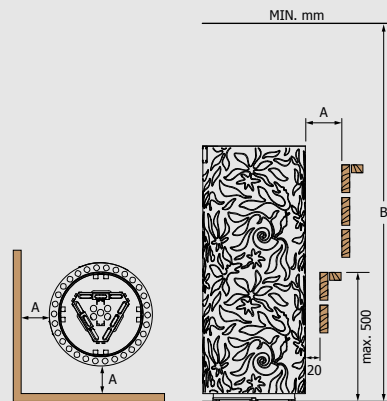

Minimum Safety Distances

Separate Control

HEATER MODEL	kW	SAUNA ROOM		SIZE OF HEATER			STONES (KG)	CONTROL	MINIMUM SAFETY DISTANCES	
		MIN (m³)	MAX	WIDTH	DEPTH (mm)	HEIGHT			A	B
DRF3-45NS	4,5	3	6	365	365	930	60	separate	100	1900
DRF3-60NS	6,0	5	9	365	365	930	60	separate	100	1900
DRF3-75NS	7,5	7	13	365	365	930	60	separate	100	1900
DRF3-90NS	9,0	8	14	365	365	930	60	separate	100	1900





Sauna HEATERS

FLOOR Series

SAWO Floor Series features movable, high-performance, stand-alone sauna heaters that ensure optimal heat distribution and comfort, enhancing your sauna experience with sleek, durable designs.

WARNING! VARNING! VARNUNG! VYSTRAHA! ADVERTENCIA! WAARSCHUWING!
OPOZORILO! OSTRZEZENIE! FIGYELMEZTETESI! AVERHOSEMENT!

Helius

This modern, “hidden” heater with slim shape gives you flexibility on heater placement. **Helius** requires only a small safety distance (min. 5mm), to decrease the safety distance even more minimal, add separate Helius hood. To get more space for benches, Helius can be installed behind the benches. The genius airflow design creates ventilation in the heater, which heats up air inside the sauna more efficiently. Perfect especially for small to medium sized saunas to (3m³ - 14m³).

- » Power range 4.5 - 9.0kW
- » Available controlling NS
- » Separate soapstone water basin with hose
- » Sauna Experience: Hot, Sharp heat
- » Optional heater guard and Helius Hood



Helius
(NS)



Technical DATA

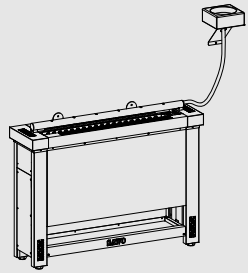

Heliuss

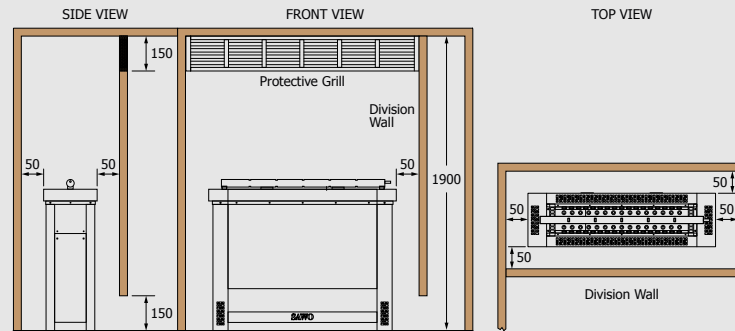

Minimum Safety Distances (Recess Wall)

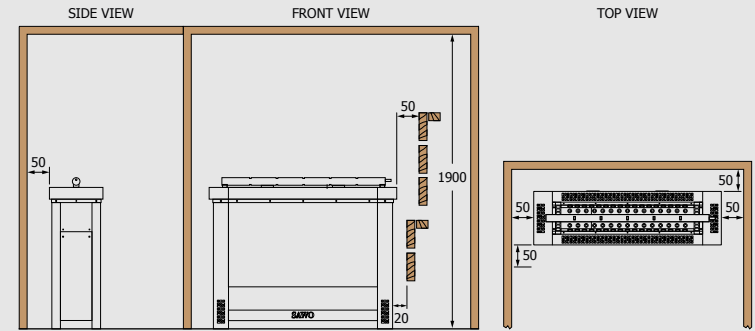

Minimum Safety Distances (Normal Installation)

Separate Control

HEATER MODEL	kW	SAUNA ROOM		SIZE OF HEATER			STONES (kg)	CONTROL
		MIN	MAX	WIDTH	DEPTH	HEIGHT		
HES-45NS	4,5	3	6	860	230	655	19	separate
HES-60NS	6,0	5	8	860	230	655	19	separate
HES-75NS	7,5	7	12	860	230	655	19	separate
HES-90NS	9,0	8	14	860	230	655	19	separate

Other features:

- » Floor standing
- » Stones are not in contact with heating elements
- » Water accessory is included for recess wall installation
- » Can fit 17kg of stones
- » 4,5kW - 9,0kW power
- » Catch pan included
- » Separate control
- » Adjustable legs

Heliuss with Hood (Optional)

- » Keep a small space for wall divider to recess area so heater can go below the bench.



Heater Accessories (Optional)

Heliuss Heater Guards

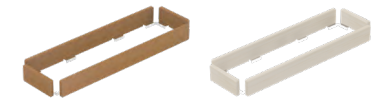

Wooden
Cedar (D) & Aspen (A)

MODEL	SIZE OF GUARD RAIL (mm)		
	WIDTH	DEPTH	HEIGHT
HES-GUARD-W-D	910	278	88
HES-GUARD-W-A	910	278	88



Taurus

Taurus is a professional heater with advance sensory system that detects early stage of heating element malfunctions. The rock container keeps stones separated from the heating elements which increases life span of the heating elements.

Taurus D revolutionizes the standard sauna heater, by having 2 heating element options in same heater. Choose between using 9kW or 12kW depending on the space the heater is installed.

- » Power range 9.0 - 24.0kW
- » Available controlling NS
- » Sauna Experience: Hot, Sharp heat to milder and more humid
- » Optional heater guard



Technical DATA

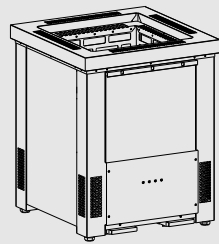

Taurus

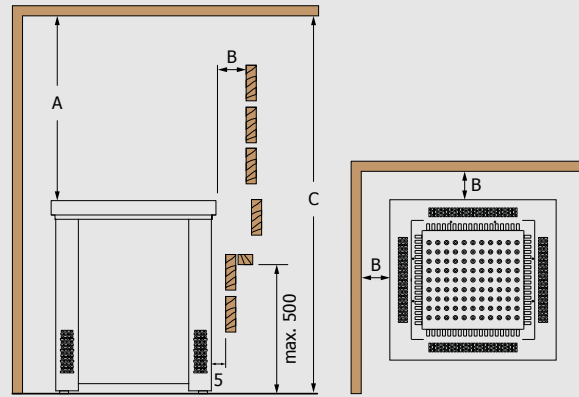

Minimum Safety Distances

Easy access to change heating elements through cassette pull-out tray.

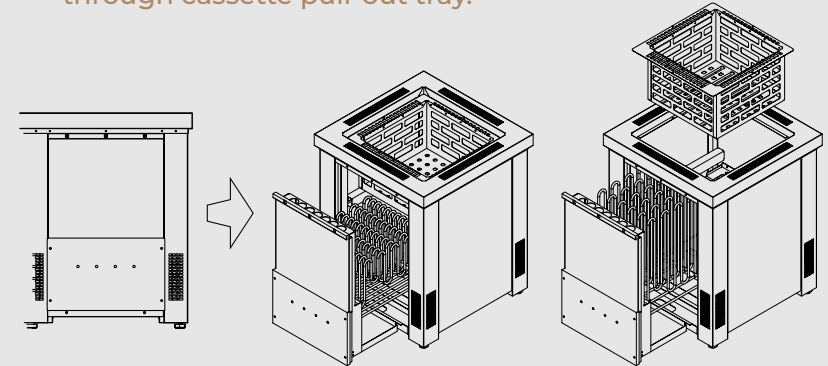

Taurus (NS)

Taurus D

HEATER MODEL	kW	SAUNA ROOM		SIZE OF HEATER			STONES (kg)	CONTROL	MINIMUM SAFETY DISTANCES		
		MIN (m³)	MAX	WIDTH	DEPTH	HEIGHT			A	B	C
TRD-90/120NS-G-P	9,0 12,0	8	14	555	555	685	50	separate	1210	5/*50	1900
TRD-180/210/240NS-G-P	18,0 21,0 24,0	24	40	955	555	685	100	separate	1410	5/*50	2100

*For commercial use.



Taurus Combi (NS) NEW!

Taurus D Combi

HEATER MODEL	kW	SAUNA ROOM		SIZE OF HEATER			STONES (kg)	CONTROL	MINIMUM SAFETY DISTANCES		
		MIN (m³)	MAX	WIDTH	DEPTH	HEIGHT			A	B	C
TRDC-90/120NS-G-P	9,0 12,0	8	14	555	595	685	50	separate	1210	5/*50	1900
TRDC-180/210/240NS-G-P	18,0 21,0 24,0	24	40	955	595	685	100	separate	1410	5/*50	2100

*For commercial use.

Heater Accessories (Optional)

Taurus Heater Guards



Wooden Heater Guard for TRD-90/120 Cedar (D), Aspen (A), & Black (BL)

MODEL	SIZE OF GUARD RAIL		
	WIDTH	DEPTH	HEIGHT
TAU-GUARD-W9-D A BL	554	102	135

Wooden Heater Guard for TRD-180/210/240 Cedar (D), Aspen (A), & Black (BL)

MODEL	SIZE OF GUARD RAIL		
	WIDTH	DEPTH	HEIGHT
TAU-GUARD-V12-D A BL	102	704	135

Heater Guard Rails





Krios Floor

Krios is now available also as floor heater with same stainless steel casing with signature SAWO-pattern. With more stones, Krios gives more steam. Perfect especially for medium to large sized saunas to bring smooth and humid heat (8m³ - 42m³).



Technical DATA

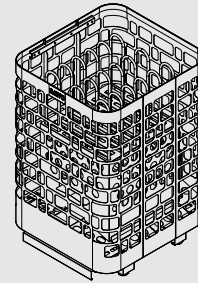

Krios Floor

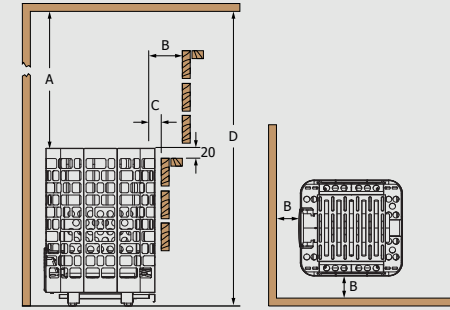

Minimum Safety Distances

Separate Control

HEATER MODEL	kW	SAUNA ROOM (m ³)		SIZE OF HEATER (mm)			STONES (kg)	CONTROL	MINIMUM SAFETY DISTANCES			
		MIN	MAX	WIDTH	DEPTH	HEIGHT			A	B	C	D
KRFS-90NS	9,0	8	14	500	460	715	160	separate	1200	100	20	1900
KRFS-105NS	10,5	9	15	500	460	715	160	separate	1200	100	20	1900
KRFS-120NS	12,0	10	18	500	460	715	160	separate	1400	100	20	2100
KRFS-150NS	15,0	13	23	680	460	715	210	separate	1400	100	160	2100
KRFS-180NS	18,0	17	29	680	460	715	210	separate	1400	100	160	2100
KRFS-180NS-V12	18,0	18	30	860	460	715	260	separate	1400	160	100	2100
KRFS-210NS-V12	21,0	22	35	860	460	715	260	separate	1400	160	100	2100
KRFS-240NS-V12	24,0	26	42	860	460	715	260	separate	1400	160	100	2100



Krios Floor (NS)

- » Power range 9.0 - 24.0kW
- » Available controlling NS
- » Sauna Experience: Medium smooth heat, Humid

Savonia

Savonia models are electric heaters designed to withstand extreme heat with only little care and maintenance. They can handle large amount of stones for more pleasant sauna steam. Savonia heaters are with adjustable leg support that keeps the heater stand leveled on the floor. Suitable for especially for commercial saunas. Perfect especially for medium to large sized saunas to (8m³ - 42m³).

Available with cool-to-touch fiber coating.

- » Power range 9.0 - 24.0kW
- » Available controlling NS
- » Sauna Experience: Medium heat, with mild steam

Technical DATA

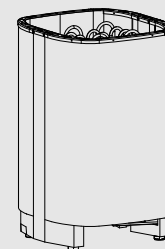

Savonia

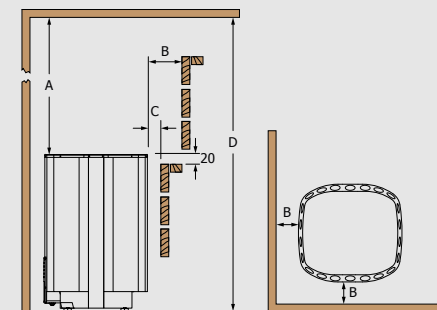

Minimum Safety Distances



Separate Control

HEATER MODEL	kW	SAUNA ROOM (m ³)		SIZE OF HEATER (mm)			STONES (kg)	CONTROL	MINIMUM SAFETY DISTANCES (mm)			
		MIN	MAX	WIDTH	DEPTH	HEIGHT			A	B	C	D
SAV-90NS	9,0	8	14	440	420	655	50	separate	1200	110	50	1900
SAV-105NS	10,5	9	15	440	420	655	50	separate	1200	120	60	1900
SAV-120NS	12,0	10	18	440	420	655	50	separate	1400	130	70	2100
SAV-150NS	15,0	13	23	590	420	655	75	separate	1400	160	100	2100
SAV-180NS	18,0	17	29	590	420	655	75	separate	1400	160	100	2100
SAV-180NS-V12	18,0	18	30	740	420	655	100	separate	1400	160	100	2100
SAV-210NS-V12	21,0	22	35	740	420	655	100	separate	1400	160	100	2100
SAV-240NS-V12	24,0	26	42	740	420	655	100	separate	1400	160	100	2100



Savonia (NS)



Savonia Fibercoated (NS)



Savonia Combi

Savonia model with combi-tank. Balance the hot and sharp heat with additional water tank for more steam. Perfect especially for medium to large sized saunas to (8m³ - 29m³). Available with cool-to-touch fiber coating and with auto-refill.



Technical DATA

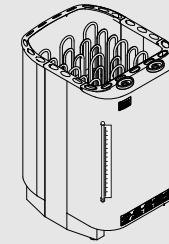

Savonia Combi

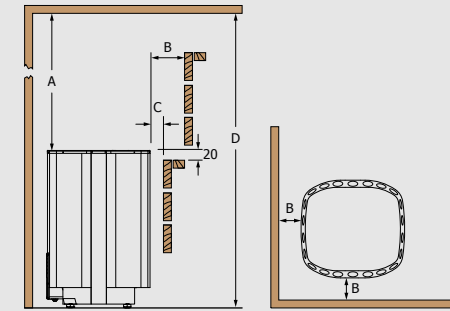

Minimum Safety Distances

- » Power range 9.0 - 18.0kW
- » Available controlling NS
- » Built-in aroma cups
- » Optional auto-refill, for automatically filled water tank
- » Sauna Experience: Medium heat and humidity

Combi Control

HEATER MODEL	kW	SAUNA ROOM		SIZE OF HEATER			STONES (kg)	CONTROL	MINIMUM SAFETY DISTANCES			
		MIN (m ³)	MAX (m ³)	WIDTH	DEPTH (mm)	HEIGHT			A	B	C	D
SAVC-90NS	9,0	8	14	510	420	655	50	separate	1200	110	50	1900
SAVC-105NS	10,5	9	15	510	420	655	50	separate	1200	120	60	1900
SAVC-120NS	12,0	10	18	510	420	655	50	separate	1400	130	70	2100
SAVC-150NS	15,0	13	23	715	420	655	75	separate	1400	160	100	2100
SAVC-180NS	18,0	17	29	715	420	655	75	separate	1400	160	100	2100



Savonia Combi (NS)



Savonia Combi Fibercoated (NS)

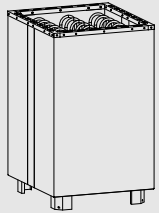

Nordex FLOOR

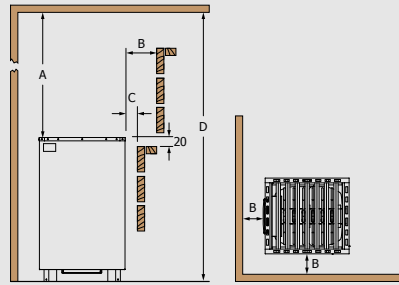

Minimum Safety Distances

- » Power range 9.0 - 24.0kW
- » Available controlling NS
- » Sauna Experience: Hot, Sharp heat

Separate Control

HEATER MODEL	kW	SAUNA ROOM (m³)		SIZE OF HEATER			STONES (KG)	CONTROL	MINIMUM SAFETY DISTANCES			
		MIN	MAX	WIDTH	DEPTH	HEIGHT			A	B	C	D
NRFS-90NS	9,0	8	14	450	400	670	50	separate	1200	120	50	1900
NRFS-105NS	10,5	9	15	450	400	670	50	separate	1200	120	60	1900
NRFS-120NS	12,0	10	18	450	400	670	50	separate	1400	130	70	2100
NRFS-150NS	15,0	13	23	595	400	670	75	separate	1400	160	100	2100
NRFS-180NS	18,0	17	29	595	400	670	75	separate	1400	160	100	2100
NRFS-180NS-V12	18,0	18	30	740	400	670	100	separate	1400	160	100	2100
NRFS-210NS-V12	21,0	22	35	740	400	670	100	separate	1400	160	100	2100
NRFS-240NS-V12	24,0	26	42	740	400	670	100	separate	1400	160	100	2100



Nordex Floor (NS)



Nordex Floor Black (NS)

Nordex Floor

Nordex floor is a floor-standing heater with simple and minimalist design. Available with black metal casing. Perfect especially for medium to large sized saunas to bring smooth and humid heat (8m³ - 42m³).

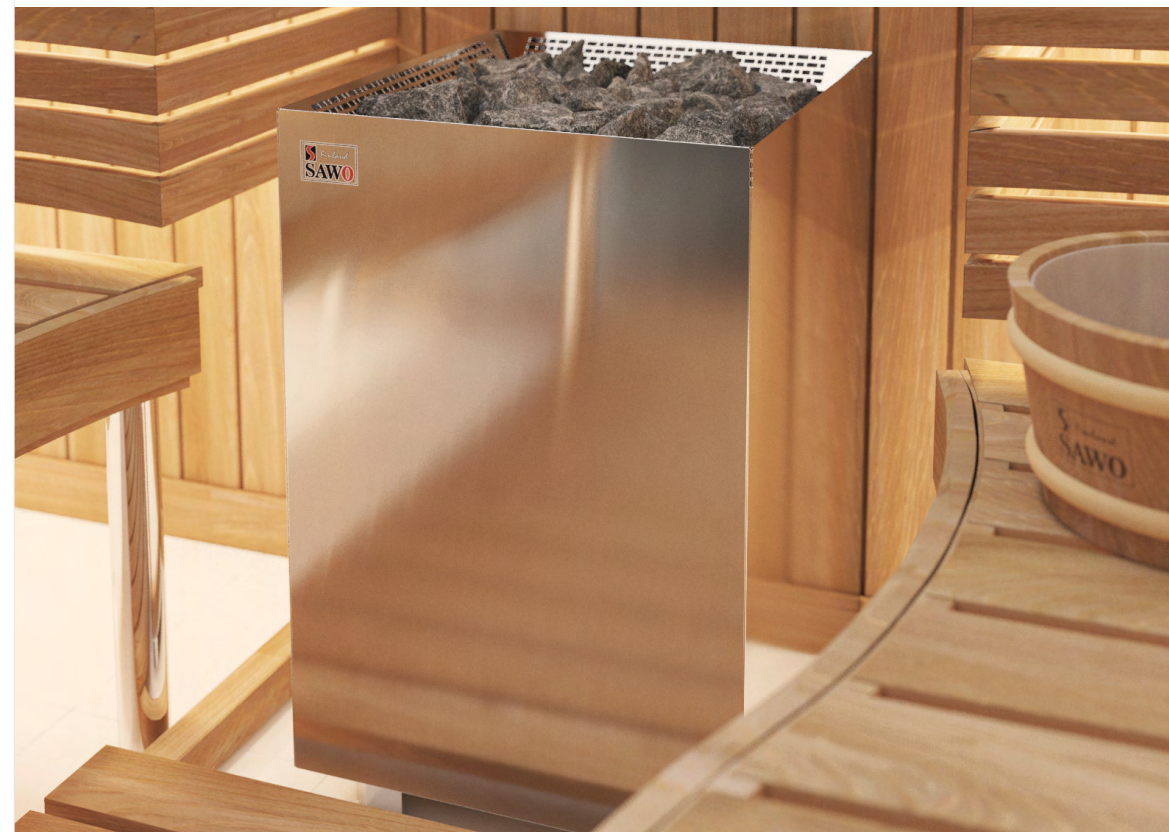



Nordex S

Nordex S is new version of Nordex Floor with sleeker design. This heater can be placed easily to different sauna room layout due to the slimmer design. Also available with black metal casing. Perfect especially for medium sized saunas (5m³ - 14m³).



Technical DATA



Nordex S

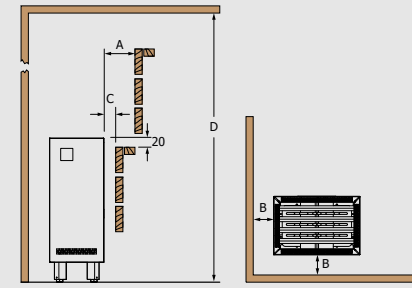

Minimum Safety Distances

- » Power range 6.0 - 9.0kW
- » Available controlling NS
- » Sauna Experience: Hot, Sharp heat

Separate Control

HEATER MODEL	kW	SAUNA ROOM (m ³)		SIZE OF HEATER (mm)			STONES (kg)	CONTROL	MINIMUM SAFETY DISTANCES (mm)			
		MIN	MAX	WIDTH	DEPTH	HEIGHT			A	B	C	D
NRNS-6ONS	6,0	5	9	270	395	710	18 - 25	separate	50	50	5	1900
NRNS-6ONS-BL	6,0	5	9	270	395	710	18 - 25	separate	50	50	5	1900
NRNS-8ONS	8,0	7	13	270	395	710	18 - 25	separate	80	80	5	1900
NRNS-8ONS-BL	8,0	7	13	270	395	710	18 - 25	separate	80	80	5	1900
NRNS-9ONS	9,0	8	14	270	395	710	18 - 25	separate	80	80	5	1900
NRNS-9ONS-BL	9,0	8	14	270	395	710	18 - 25	separate	80	80	5	1900

Nordex S with LED Lights (Optional)

MODEL
NRNS-6ONS-L-Z-C NRNS-6ONS-BL-L-Z-C
NRNS-8ONS-L-Z-C NRNS-8ONS-BL-L-Z-C
NRNS-9ONS-L-Z-C NRNS-9ONS-BL-L-Z-C



Nordex S (NS)



Nordex S Black (NS)

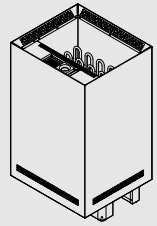

Nordex S Combi

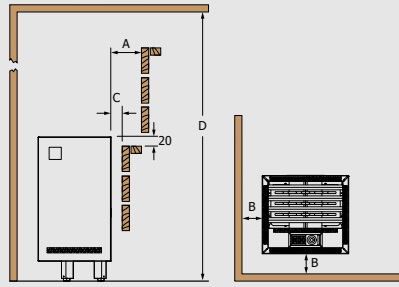

Minimum Safety Distances

- » Power range 6.0 - 9.0kW
- » Available controlling NS
- » Separate water tank with 0.8kW or 2kW steam generator
- » Built-in aroma cups for aroma therapy
- » Sauna Experience: Hot, Sharp heat to Milder steam

Separate Control

HEATER MODEL	kW	SAUNA ROOM (m³)		SIZE OF HEATER			STONES (kg)	CONTROL	MINIMUM SAFETY DISTANCES			
		MIN	MAX	WIDTH	DEPTH	HEIGHT			A	B	C	D
NRNSC-60NS	6,0	5	9	270	395	710	8	separate	5	50	5	1990
NRNSC-60NS-BL	6,0	5	9	270	395	710	8	separate	5	50	5	1990
NRNSC-80NS	8,0	7	13	270	395	710	8	separate	5	80	5	1990
NRNSC-80NS-BL	8,0	7	13	270	395	710	8	separate	5	80	5	1990
NRNSC-90NS	9,0	8	14	270	395	710	8	separate	5	80	5	1990
NRNSC-90NS-BL	9,0	8	14	270	395	710	8	separate	5	80	5	1990



Nordex S Combi (NS)



Nordex S Combi Black (NS)

Nordex S Combi

The **Nordex S Combi** is now available in a steamier version. Balance the intense heat with an additional water tank for more steam. Also available with a black metal casing, it's perfect for medium-sized saunas (5m³ - 14m³).





Mini
(NB)



Mini
Fibercoated
(NB)



Mini X
(NS | NB)



Mini X
Fibercoated
(NS | NB)



Mini Combi
(NS)



Mini Combi
Fibercoated
(NS)

Mini

Mini heater is the solution for small, 1 – 2 persons sauna rooms. Due to its small size and from left to right reversible control unit, Mini heater can be placed in very small locations. Available also with cool-to-touch fiber-coating.

Best for small sauna (1.3m³ - 6m³).

- » Power range 2.3 - 3.6kW
- » Available controlling NB
- » Sauna Experience: Hot, Sharp heat

Mini X

Mini X is an ideal heater for sauna rooms with extremely limited space. It is placed in corner of sauna room, allowing the maximum space for sauna use. Available also with cool-to-touch fiber-coating.

Best for small sauna (1.3m³ - 6m³).

- » Power range 2.3 - 3.6kW
- » Available controlling NS, NB
- » Sauna Experience: Hot, Sharp heat

Mini Combi

Mini heater with additional combi water tank for increased humidity. Available also with cool-to-touch fiber-coating.

Best for small sauna (2m³ - 6m³).

- » Power range 3.0 - 3.6kW
- » Available controlling NS
- » Separate water tank with 1kW steam generator
- » Built-in aroma cup for aroma therapy
- » Sauna Experience: Hot, Sharp heat to mildly humid



Technical DATA

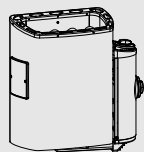

Mini

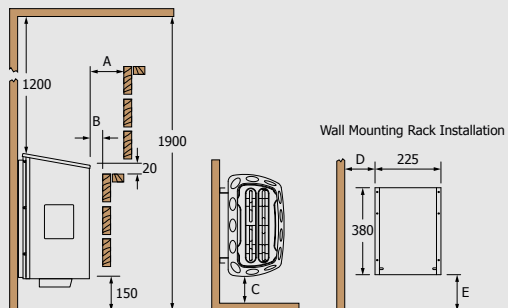

Minimum Safety Distances

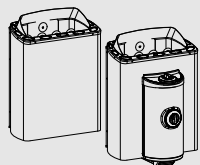

Mini X

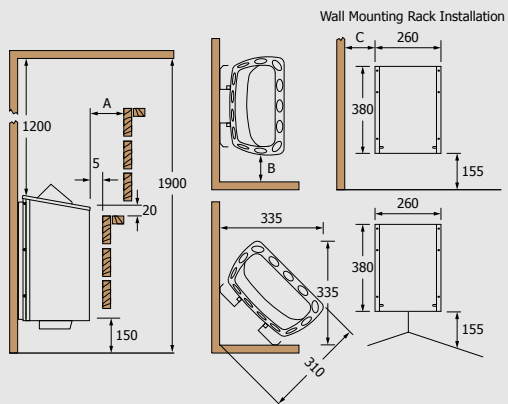

Minimum Safety Distances

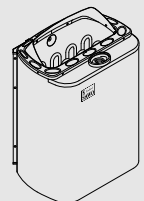

Mini Combi

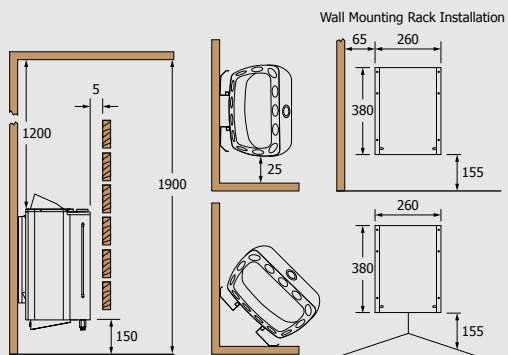

Minimum Safety Distances

Built-in Control

HEATER MODEL	kW	SAUNA ROOM		SIZE OF HEATER			STONES (kg)	CONTROL	MINIMUM SAFETY DISTANCES				
		MIN (m³)	MAX	WIDTH	DEPTH	HEIGHT			A	B	C	D	E
MN-23NB	2,3	1,3	2,5	435	*215	**455	11	built-in	100	20	100	140	155
MN-30NB	3,0	2	4	435	*215	**455	11	built-in	100	20	100	140	155
MN-36NB	3,6	3	6	435	*215	**455	11	built-in	100	20	100	140	155

*Depth when installed to the wall.

**Reflector not included.

Separate Control

HEATER MODEL	kW	SAUNA ROOM		SIZE OF HEATER			STONES (kg)	CONTROL	MINIMUM SAFETY DISTANCES		
		MIN (m³)	MAX	WIDTH	DEPTH	HEIGHT			A	B	C
MX-23NS	2,3	1,3	2,5	330	*200/320	495	11	separate	30	20	60
MX-30NS	3,0	2	4	330	*200/320	495	11	separate	35	25	65
MX-36NS	3,6	3	6	330	*200/320	495	11	separate	40	25	65

Built-in Control

HEATER MODEL	kW	SAUNA ROOM		SIZE OF HEATER			STONES (kg)	CONTROL	MINIMUM SAFETY DISTANCES		
		MIN (m³)	MAX	WIDTH	DEPTH	HEIGHT			A	B	C
MX-23NB	2,3	1,3	2,5	330	*310/435	485	11	built-in	30	20	60
MX-30NB	3,0	2	4	330	*310/435	485	11	built-in	35	25	65
MX-36NB	3,6	3	6	330	*310/435	485	11	built-in	40	25	65

*Wall mounted/corner mounted.

Combi Control

HEATER MODEL	kW	SAUNA ROOM		SIZE OF HEATER			STONES (kg)	CONTROL
		MIN (m³)	MAX	WIDTH	DEPTH	HEIGHT		
MNC-23NS	2,3	2	4	330	*260	500	8-10,5	separate
MNC-23NSF	2,3	2	4	330	*260	500	8-10,5	separate
MNC-30NS	3,0	2	4	330	*260	500	8-10,5	separate
MNC-30NSF	3,0	2	4	330	*260	500	8-10,5	separate
MNC-36NS	3,6	3	6	330	*260	500	8-10,5	separate
MNC-36NSF	3,6	3	6	330	*260	500	8-10,5	separate

*Depth when installed to the wall.

**Reflector not included.

Scandia

Scandia is a stable classic of sauna heaters. This simple heater gives the traditional Finnish sauna experience. Available also with cool-to-touch fiber-coating.

Best for small to medium sized sauna (3m³ - 14m³).

- » Power range 4.5 - 9.0kW
- » Available controlling NS, NB
- » Sauna Experience: Hot, Sharp heat



Technical DATA

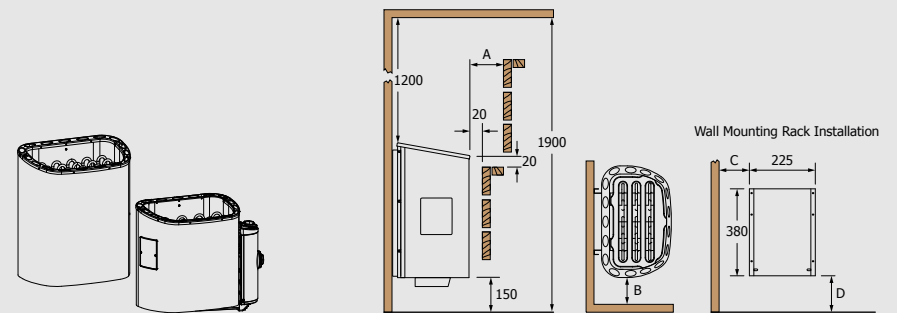

Scandia

Minimum Safety Distances



Scandia (NS)

Scandia Fibercoated (NS)

Scandia (NB)

Scandia Fibercoated (NB)

Separate Control

HEATER MODEL	kW	SAUNA ROOM		SIZE OF HEATER			STONES (kg)	CONTROL	MINIMUM SAFETY DISTANCES			
		MIN (m ³)	MAX (m ³)	WIDTH	DEPTH (mm)	HEIGHT			A	B	C	D
SCA-45NS	4,5	3	6	410	*290	**455	22	separate	100	100	135	155
SCA-60NS	6,0	5	8	410	*290	**455	22	separate	100	100	135	155
SCA-80NS	8,0	7	13	410	*290	**525	22	separate	100	100	135	235
SCA-90NS	9,0	8	14	410	*290	**525	22	separate	100	100	135	235

Built-in Control

HEATER MODEL	kW	SAUNA ROOM		SIZE OF HEATER			STONES (kg)	CONTROL	MINIMUM SAFETY DISTANCES			
		MIN (m ³)	MAX (m ³)	WIDTH	DEPTH (mm)	HEIGHT			A	B	C	D
SCA-45NB	4,5	3	6	515	*290	**455	22	built-in	100	100	185	155
SCA-60NB	6,0	5	8	515	*290	**455	22	built-in	100	100	185	155
SCA-80NB	8,0	7	13	515	*290	**525	22	built-in	100	100	185	235
SCA-90NB	9,0	8	14	515	*290	**525	22	built-in	100	100	185	235

*Depth when installed to the wall.

**Reflector not included.



Scandia Combi

Scandia heater with additional combi water tank for increased humidity. Available also with cool-to-touch fiber-coating.

Best for small to medium sized sauna (5m³ - 14m³).

- » Power range 6 - 9.0kW
- » Available controlling NS
- » Separate water tank with 1kW or 2kW steam generator
- » Built-in aroma cup for aroma therapy
- » Sauna Experience: Hot, Sharp heat to mildly humid

Technical DATA

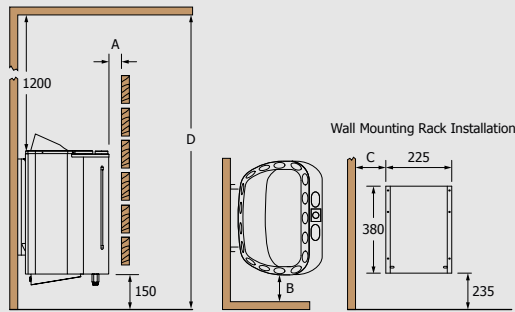
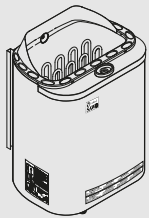

Scandia Combi

Minimum Safety Distances for Scandia Combi



Combi Control

HEATER MODEL	kW	SAUNA ROOM		SIZE OF HEATER			STONES (kg)	CONTROL	MINIMUM SAFETY DISTANCES			
		MIN (m ³)	MAX (m ³)	WIDTH	DEPTH (mm)	HEIGHT			A	B	C	D
SCAC-60NS	6,0	5	9	410	*365	595	18-22	separate	5	50	135	1900
SCAC-80NS	8,0	7	13	410	*365	595	18-22	separate	5	50	135	1900
SCAC-90NS	9,0	8	14	410	*365	595	18-22	separate	5	50	135	1900

*Depth when installed to the wall.



Scandia Combi (NS)



Scandia Combi Fibercoated (NS)

Krios

This beautiful wall-mounted heater has stainless steel casing with signature SAWO-pattern. Inspired by Aries and Cubos models, this heater is something you have never seen before.

With more stones, **Krios** gives more steam. Perfect especially for small and medium sized saunas to bring smooth and humid heat.



Krios
(Ni2)



Krios
(NS)



Krios
(NB)



Technical DATA

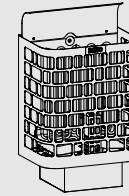

Krios

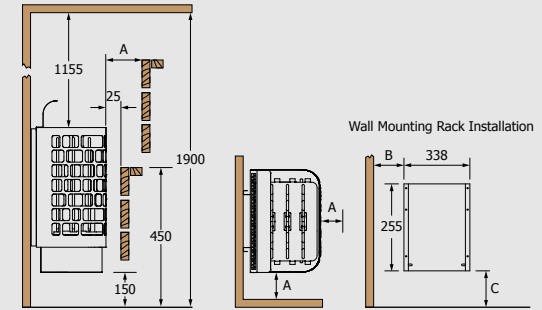

Minimum Safety Distances

Ni2 Version

HEATER MODEL	kW	SAUNA ROOM		SIZE OF HEATER			STONES (kg)	CONTROL	MINIMUM SAFETY DISTANCES		
		MIN (m³)	MAX	WIDTH	DEPTH	HEIGHT			A	B	C
KRI-45Ni2	4,5	3	6	390	*290	**600	40	Saunova 2.0	50	75	345
KRI-60Ni2	6,0	5	9	390	*290	**600	40	Saunova 2.0	80	105	345
KRI-80Ni2	8,0	7	13	390	*290	**670	50	Saunova 2.0	100	125	415
KRI-90Ni2	9,0	8	14	390	*290	**670	50	Saunova 2.0	100	125	415

Separate Control

HEATER MODEL	kW	SAUNA ROOM		SIZE OF HEATER			STONES (kg)	CONTROL	MINIMUM SAFETY DISTANCES		
		MIN (m³)	MAX	WIDTH	DEPTH	HEIGHT			A	B	C
KRI-45NS	4,5	3	6	390	*290	**580	40	Innova	50	75	320
KRI-60NS	6,0	5	9	390	*290	**580	40	Innova	80	105	320
KRI-80NS	8,0	7	13	390	*290	**650	50	Innova	100	125	390
KRI-90NS	9,0	8	14	390	*290	**650	50	Innova	100	125	390

Built-in Control

HEATER MODEL	kW	SAUNA ROOM		SIZE OF HEATER			STONES (kg)	CONTROL	MINIMUM SAFETY DISTANCES		
		MIN (m³)	MAX	WIDTH	DEPTH	HEIGHT			A	B	C
KRI-45NB	4,5	3	6	390	*290	**580	40	Built-in	50	75	320
KRI-60NB	6,0	5	9	390	*290	**580	40	Built-in	80	105	320
KRI-80NB	8,0	7	13	390	*290	**650	50	Built-in	100	125	390
KRI-90NB	9,0	8	14	390	*290	**650	50	Built-in	100	125	390

*Depth when installed to the wall.

**Height with reflector.

Heater Accessories (Optional)

Krios Heater Guards

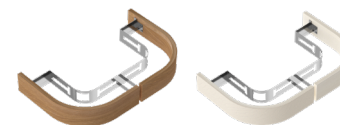

Wooden
Cedar (D) & Aspen (A)

MODEL	SIZE OF GUARD RAIL		
	WIDTH	DEPTH	HEIGHT
KRI-GUARD-W-D	388	112	690
KRI-GUARD-W-A	388	112	690



Krios

- » Wall mounted
- » Stainless steel casing
- » Heat reflector included
- » Control can be rotated to left, front and right
- » Can fit 50kg of stones
- » 4,5kW - 9,0kW power
- » Built-in, separate, Ni2 control



Nordex

Nordex heater with minimalist and modern design. This heater is also available with black metal casing.

- » Power range 4.5 - 9.0kW
- » Available controlling Ni2, NS, NB
- » Sauna Experience: Hot, Sharp heat

Perfect especially for small to medium sized saunas to (3m³ - 14m³).



Nordex (Ni2)

Nordex Black (Ni2)

Nordex (NS)

Nordex Black (NS)

Nordex (NB)

Nordex Black (NB)

Technical DATA

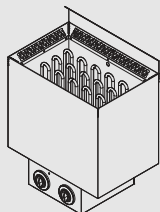

Nordex

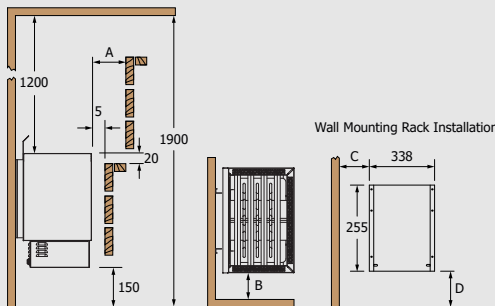

Minimum Safety Distances

Ni2 Version

HEATER MODEL	kW	SAUNA ROOM		SIZE OF HEATER			STONES (kg)	CONTROL	MINIMUM SAFETY DISTANCES			
		MIN (m ³)	MAX (m ³)	WIDTH	DEPTH (mm)	HEIGHT			A	B	C	D
NR-45Ni2	4,5	3	6	410	*300	**510	22	Saunova 2.0	50	50	130	270
NR-60Ni2	6,0	5	9	410	*300	**510	22	Saunova 2.0	50	50	130	270
NR-80Ni2	8,0	7	13	410	*300	**585	22	Saunova 2.0	80	80	160	330
NR-90Ni2	9,0	8	14	410	*300	**585	22	Saunova 2.0	80	80	160	330

Built-in | Separate Control

HEATER MODEL	kW	SAUNA ROOM		SIZE OF HEATER			STONES (kg)	CONTROL	MINIMUM SAFETY DISTANCES			
		MIN (m ³)	MAX (m ³)	WIDTH	DEPTH (mm)	HEIGHT			A	B	C	D
NR-45NB NS	4,5	3	6	400	*295	**515	18-22	8 + 4h	50	50	80	320
NR-60NB NS	6,0	5	9	400	*295	**515	18-22	8 + 4h	50	50	80	320
NR-80NB NS	8,0	7	13	400	*295	**590	18-22	8 + 4h	80	80	110	395
NR-90NB NS	9,0	8	14	400	*295	**590	18-22	8 + 4h	80	80	110	395

*Depth when installed to the wall.
**Height with reflector.

Heater Accessories (Optional)

Nordex Heater Guards

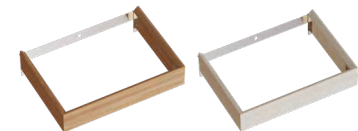

Wooden Cedar (D) & Aspen (A)

MODEL	SIZE OF GUARD RAIL (mm)		
	WIDTH	DEPTH	HEIGHT
NRN-GUARD-W-D	462	100	75
NRN-GUARD-W-A	462	100	75

Nordex Combi

- Nordex** in combi version, helps to add humidity to the heat. This heater is also available with black metal casing.
- Perfect especially for small to medium sized saunas to (5m³ - 14m³).
- » Power range 6.0 - 9.0kW
 - » Available controlling NS
 - » Separate water tank with 0.8kW or 2kW steam generator
 - » Built-in aroma cups for aroma therapy
 - » Sauna Experience: Hot, Sharp heat to milder humid heat

Combi Control

HEATER MODEL	kW	SAUNA ROOM		SIZE OF HEATER			STONES (kg)	CONTROL
		MIN (m ³)	MAX (m ³)	WIDTH	DEPTH (mm)	HEIGHT (mm)		
NRC-60NS	6,0	5	9	410	*365	**580	22	Innova
NRC-80NS	8,0	7	13	410	*365	**580	22	Innova
NRC-90NS	9,0	8	14	410	*365	**580	22	Innova

*Depth when installed to the wall.

**Height with reflector.



Nordex Combi (NS)



Nordex Combi Black (NS)



Technical DATA

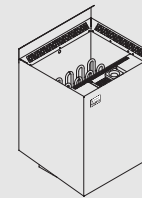

Nordex Combi

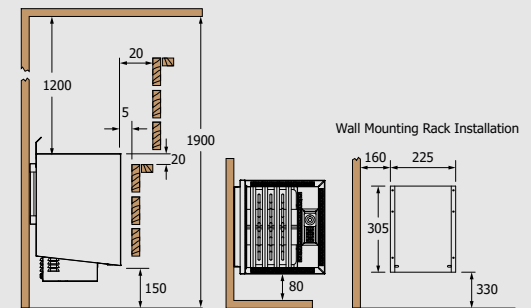

Minimum Safety Distances

Nordex Mini

Nordex Mini can be wall-mounted in straight or corner position. This heater is also available with black metal casing.

Perfect especially for small sized saunas to (1.3m³ - 6m³).

- » Power range 2.3 - 3.60kW
- » Available controlling Ni2, NS, NB
- » Sauna Experience: Hot, Sharp heat

! For more technical information, see page 57.



Nordex Mini (Ni2)

Nordex Mini Black (Ni2)



Nordex Mini (NS)

Nordex Mini Black (NS)



Nordex Mini (NB)

Nordex Mini Black (NB)

Nordex Mini Combi

Nordex Mini in combi version, helps to add humidity to the heat. This heater is also available with black metal casing.

Perfect especially for small sized saunas to (12m³ - 6m³).

- » Power range 3 - 3.6kW
- » Available controlling NS
- » Separate water tank with 0.8kW steam generator
- » Built-in aroma cups for aroma therapy
- » Sauna Experience: Hot, Sharp heat to milder humid heat

! For more technical information, see page 57.



Nordex Mini Combi
(NS)



Nordex Mini Combi
Black
(NS)



Technical DATA

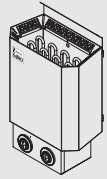

Nordex MINI

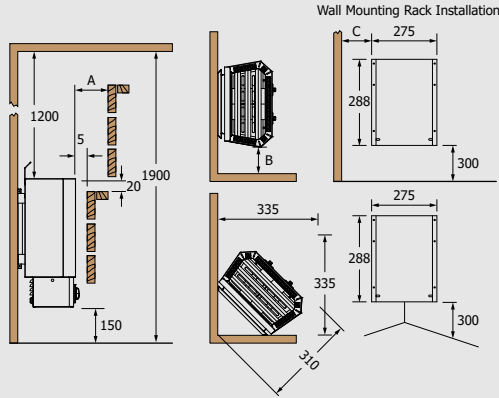

Minimum Safety Distances

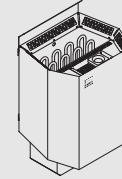

Nordex Mini Combi

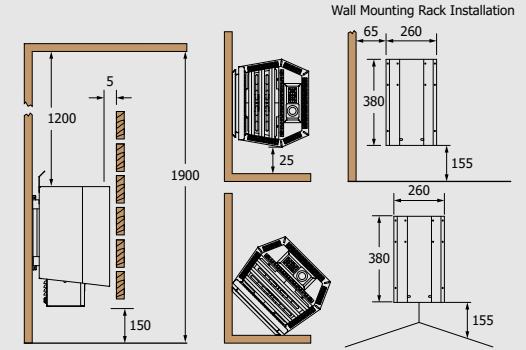

Minimum Safety Distances

Ni2 Version

HEATER MODEL	kW	SAUNA ROOM (m³)		SIZE OF HEATER			STONES (kg)	CONTROL	MINIMUM SAFETY DISTANCES		
		MIN	MAX	WIDTH	DEPTH (mm)	HEIGHT			A	B	C
NRMN-23Ni2	2,3	1,3	2,5	340	*200	500	11	Saunova	50	30	85
NRMN-30Ni2	3,0	2	4	340	*200	500	11	Saunova	50	30	85
NRMN-36Ni2	3,6	3	6	340	*200	500	11	Saunova	50	30	85

Combi Control

HEATER MODEL	kW	SAUNA ROOM (m³)		SIZE OF HEATER			STONES (kg)	CONTROL
		MIN	MAX	WIDTH	DEPTH (mm)	HEIGHT		
NRMNC-30NS Ni2	3,0	2	4	340	*240	500	11	separate Saunova
NRMNC-36NS Ni2	3,6	3	6	340	*240	500	11	separate Saunova

*Depth when installed to the wall.

Built-in | Separate Control

HEATER MODEL	kW	SAUNA ROOM (m³)		SIZE OF HEATER			STONES (kg)	CONTROL	MINIMUM SAFETY DISTANCES		
		MIN	MAX	WIDTH	DEPTH (mm)	HEIGHT			A	B	C
NRMN-23NB NS	2,3	1,3	2,5	340	*200	500	11	built-in separate	30 50	20 30	60 85
NRMN-30NB NS	3,0	2	4	340	*200	500	11	built-in separate	35 50	25 30	65 85
NRMN-36NB NS	3,6	3	6	340	*200	500	11	built-in separate	40 50	25 30	65 85

*Depth when installed to the wall.



Scandifire

Scandifire by *Stefan Lindfors* gives new life to timeless classic heater Scandia. The junglefir pattern is both playful and bold, when its combined to fiber coating it makes this heater both safe and stylish.

! For more technical information, see page 60.

Scandifire

- » Power range 4,5 - 9kW
- » Fibercoated casing with junglefir pattern
- » Wall mounted
- » Can fit 22kg of stones
- » Built-in or separate control
- » Built-in models: Control knobs are with light indicator
- » Coating shields the heater from moisture and high temperature



Scandifire Red
(NB)



Scandifire Black
(NB)



Scandifire Red
(NS)



Scandifire Black
(NS)





Minidragon

Minidragon is the smallest design heater by *Stefan Lindfors*. Its innovative fiber coating stays cool throughout the sauna session, adding safety to layouts where space is limited.

! For more technical information, see page 60.



Minidragon Red
(NB)



Minidragon Black
(NB)



Minidragon Red
(NS)



Minidragon Black
(NS)

Minidragon

- » Power range 2,3kW - 3,6kW
- » Fibercoated casing with junglefire pattern
- » Wall mounted
- » Can fit 11kg of stones
- » Built-in or separate control
- » Built-in models: Control knobs are with light indicator

Technical DATA

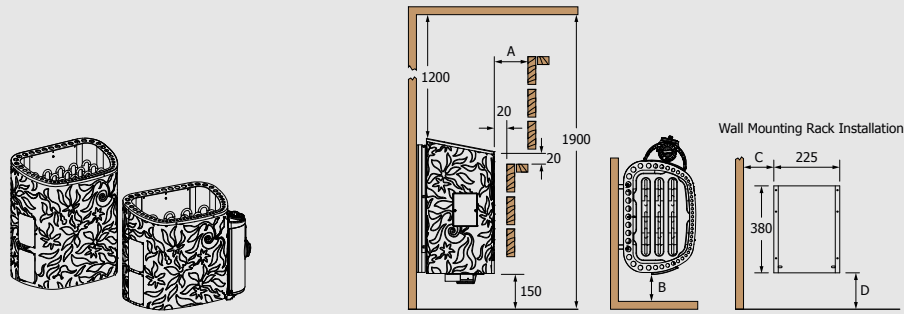

Scandifire

Minimum Safety Distances

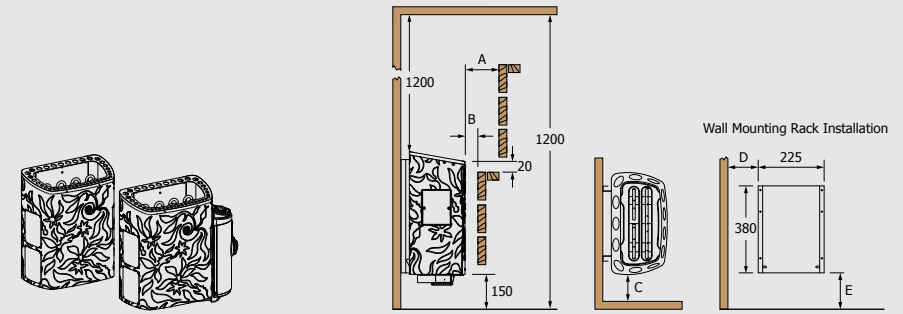

Minidragon

Minimum Safety Distances

Separate Control

HEATER MODEL	kW	SAUNA ROOM (m³)		SIZE OF HEATER (mm)			STONES (kg)	CONTROL	MINIMUM SAFETY DISTANCES			
		MIN	MAX	WIDTH	DEPTH	HEIGHT			A	B	C	D
SCA-45NS-DRF / SCA-45NS-DRF-BL	4,5	3	6	410	*290	455	18-22	separate	60	50	135	155
SCA-60NS-DRF / SCA-60NS-DRF-BL	6,0	5	8	410	*290	455	18-22	separate	60	50	135	155
SCA-80NS-DRF / SCA-80NS-DRF-BL	8,0	7	13	410	*290	525	18-22	separate	60	50	135	235
SCA-90NS-DRF / SCA-90NS-DRF-BL	9,0	8	14	410	*290	525	18-22	separate	60	50	135	235

Built-in Control

HEATER MODEL	kW	SAUNA ROOM (m³)		SIZE OF HEATER (mm)			STONES (kg)	CONTROL	MINIMUM SAFETY DISTANCES			
		MIN	MAX	WIDTH	DEPTH	HEIGHT			A	B	C	D
SCA-45NB-DRF / SCA-45NB-DRF-BL	4,5	3	6	515	*290	455	18-22	built-in	50	50	185	155
SCA-60NB-DRF / SCA-60NB-DRF-BL	6,0	5	8	515	*290	455	18-22	built-in	50	50	185	155
SCA-80NB-DRF / SCA-80NB-DRF-BL	8,0	7	13	515	*290	525	18-22	built-in	100	100	185	235
SCA-90NB-DRF / SCA-90NB-DRF-BL	9,0	8	14	515	*290	525	18-22	built-in	100	100	185	235

*Depth when installed to the wall.

Separate Control

HEATER MODEL	kW	SAUNA ROOM (m³)		SIZE OF HEATER (mm)			STONES (kg)	CONTROL	MINIMUM SAFETY DISTANCES				
		MIN	MAX	WIDTH	DEPTH	HEIGHT			A	B	C	D	E
MN-23NS-DRF / MN-23NS-DRF-BL	2,3	1,3	2,5	335	*215	455	8 - 11	separate	50	20	40	90	155
MN-30NS-DRF / MN-30NS-DRF-BL	3,0	2	4	335	*215	455	8 - 11	separate	60	20	50	90	155
MN-36NS-DRF / MN-36NS-DRF-BL	3,6	3	6	335	*215	455	8 - 11	separate	90	20	50	90	155

Built-in Control

HEATER MODEL	kW	SAUNA ROOM (m³)		SIZE OF HEATER (mm)			STONES (kg)	CONTROL	MINIMUM SAFETY DISTANCES				
		MIN	MAX	WIDTH	DEPTH	HEIGHT			A	B	C	D	E
MN-23NB-DRF / MN-23NB-DRF-BL	2,3	1,3	2,5	435	*215	455	8 - 11	built-in	50	20	40	140	155
MN-30NB-DRF / MN-30NB-DRF-BL	3,0	2	4	435	*215	455	8 - 11	built-in	60	20	50	140	155
MN-36NB-DRF / MN-36NB-DRF-BL	3,6	3	6	435	*215	455	8 - 11	built-in	90	20	80	140	155

*Depth when installed to the wall.

Sauna HEATERS

STONE Series

SAWO Stone Heaters combine durable stainless steel and heat-conducting Finnish soapstone, drying the sauna room quickly after use. The Stone Series offers a perfect heater for every type of sauna.



Nimbus

Nimbus heater is a one-of-a-kind heater design with impressive soapstone casing. This heater takes a bit longer time to heat, but once it does, it stores the heat and keeps on releasing warm and humid steam for hours.

Best for medium and large sized saunas (8m³ - 42m³).

- » Power range 9.0 - 24.0kW
- » Control: Saunova 2.0 operated
- » Built-in aroma cups
- » Sauna Experience: Mild Mellow heat, Humid

Separate Control

HEATER MODEL	kW	SAUNA ROOM		SIZE OF HEATER			STONES SOAPSTONES		CONTROL	MINIMUM SAFETY DISTANCES			
		MIN (m ³)	MAX	WIDTH	DEPTH	HEIGHT	(kg)	(kg)		A	B	C	D
NIM-90NS	9,0	8	14	520	470	690	50	80	separate	1200	110	50	1900
NIM-105NS	10,5	9	15	520	470	690	50	80	separate	1200	120	60	1900
NIM-120NS	12,0	10	18	520	470	690	50	80	separate	1400	130	70	2100
NIM-150NS	15,0	13	23	660	470	690	75	100	separate	1400	160	100	2100
NIM-180NS	18,0	17	29	660	470	690	75	100	separate	1400	160	100	2100
NIM-180NS-V12	18,0	18	30	820	470	690	100	120	separate	1400	160	100	2100
NIM-210NS-V12	21,0	22	35	820	470	690	100	120	separate	1400	160	100	2100
NIM-240NS-V12	24,0	26	42	820	470	690	100	120	separate	1400	160	100	2100



Nimbus (NS)



Technical DATA

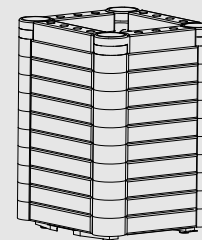

Nimbus

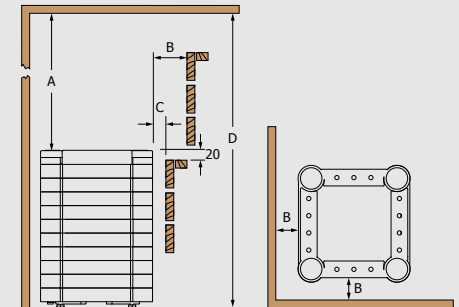

Minimum Safety Distances



Nimbus Combi

The combi version of **Nimbus** heater adds more steam with a separate water tank. Control the amount of steam released from the tank to have perfect balance of heat and humidity.

Best for large sized saunas (8m³ - 29m³).

- » Power range 9.0 - 18.0kW
- » Available controlling NS
- » Built-in aroma cups
- » Optional auto-refill, for automatically filled water tank
- » Sauna Experience: Mild Mellow heat, Very Humid

Technical DATA

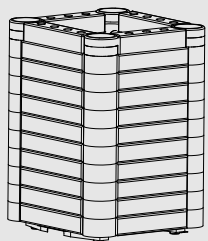

Nimbus Combi

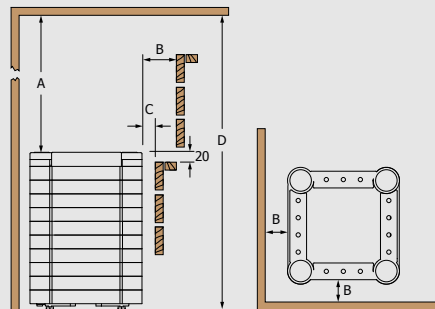

Minimum Safety Distances

Combi Control

HEATER MODEL	kW	SAUNA ROOM (m ³)		SIZE OF HEATER (mm)			STONES (kg)	SOAPSTONES (kg)	CONTROL	MINIMUM SAFETY DISTANCES			
		MIN	MAX	WIDTH	DEPTH	HEIGHT				A	B	C	D
NIMC-90NS	9,0	8	14	575	470	690	50	90	separate	1200	50	30	1900
NIMC-105NS	10,5	9	15	575	470	690	50	90	separate	1200	50	30	1900
NIMC-120NS	12,0	10	18	575	470	690	50	90	separate	1400	130	70	2100
NIMC-150NS	15,0	13	23	775	470	690	75	120	separate	1400	160	100	2100
NIMC-180NS	18,0	17	29	775	470	690	75	120	separate	1400	160	100	2100



Nimbus Combi (NS)



Technical DATA



Cumulus

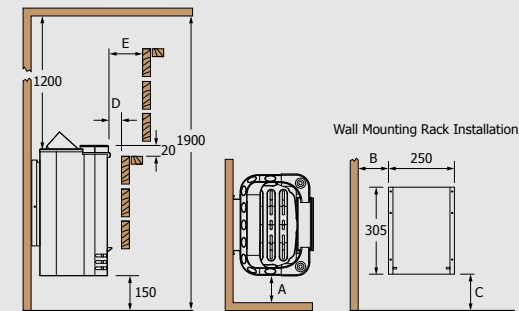

Minimum Safety Distances

Cumulus

Cumulus is an elegant wall-mounted with decorative Finnish soapstone front. Add aromatherapy to your sauna by using the aroma cups provided in the top of the heater.

Best for small and medium-sized sauna (3m³ - 14m³).

- » Power range 4.5 - 9.0kW
- » Available controlling Ni2, NS, NB
- » Built-in aroma cups
- » Sauna Experience: Medium heat, Humid



Cumulus
(Ni2)

Cumulus
(NS)

Cumulus
(NB)

Ni2 Version

HEATER MODEL	kW	SAUNA ROOM (m ³)		SIZE OF HEATER (mm)			STONES (kg)	SOAPSTONES (kg)	CONTROL	MINIMUM SAFETY DISTANCES (mm)				
		MIN	MAX	WIDTH	DEPTH	HEIGHT				A	B	C	D	E
CML-45Ni2	4,5	3	6	420	*325	500	18	10	Saunova	50	130	245	20	50
CML-60Ni2	6,0	5	8	420	*325	500	18	10	Saunova	50	130	245	20	50
CML-80Ni2	8,0	7	13	420	*325	590	22	10	Saunova	60	140	330	30	60
CML-90Ni2	9,0	8	14	420	*325	590	22	10	Saunova	60	140	330	30	60

Separate Control

HEATER MODEL	kW	SAUNA ROOM (m ³)		SIZE OF HEATER (mm)			STONES (kg)	SOAPSTONES (kg)	CONTROL	MINIMUM SAFETY DISTANCES (mm)				
		MIN	MAX	WIDTH	DEPTH	HEIGHT				A	B	C	D	E
CML-45NS	4,5	3	6	420	*325	500	18	10	separate	50	130	245	20	50
CML-60NS	6,0	5	8	420	*325	500	18	10	separate	50	130	245	20	50
CML-80NS	8,0	7	13	420	*325	590	22	10	separate	60	140	330	30	60
CML-90NS	9,0	8	14	420	*325	590	22	10	separate	60	140	330	30	60

Built-in Control

HEATER MODEL	kW	SAUNA ROOM (m ³)		SIZE OF HEATER (mm)			STONES (kg)	SOAPSTONES (kg)	CONTROL	MINIMUM SAFETY DISTANCES (mm)				
		MIN	MAX	WIDTH	DEPTH	HEIGHT				A	B	C	D	E
CML-45NB	4,5	3	6	420	*325	500	18	10	built-in	50	130	245	20	50
CML-60NB	6,0	5	8	420	*325	500	18	10	built-in	50	130	245	20	50
CML-80NB	8,0	7	13	420	*325	590	22	10	built-in	60	140	330	30	60
CML-90NB	9,0	8	14	420	*325	590	22	10	built-in	60	140	330	30	60

*Depth when installed to the wall.

HEATER Accessories



Safety Switch For Heaters



Additional safety, switch will turn off heater if foreign object is placed on top heater. Follows standard SFS-EN60335-2-53, sec 19.101



Sauna Stones

code: R-990
size: 20kg



Decorative Stones

code: R-992
size: 32pcs.

Cozy Tank

- » Water storage that adds instant steam when heater is hot
- » Refillable water via top cover holes
- » Thick stainless metal
- » Carved soapstone top cover
- » Available in 2 designs
- » Scent pockets for sauna aroma

WATER VOLUME	HEATERS
0,7 Liter	Tower (Round, Wall, Corner), Aries (Round, Wall, Corner), Phoenix, Orion, Taurus, Mini, Mini X, Scandia, Savonia,
1,3 Liter	Nordex Mini, Nordex, Nordex Floor, Nimbus, Cumulus



Cozy Tank 0.3L

Cylindrical Sauna Humidifier (Water Volume 0.3L)
code: HP01-090



Cozy Tank 0.6L

Cylindrical Sauna Humidifier (Water Volume 0.6L)
code: HP01-070

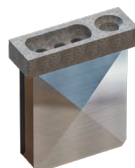

Cozy Tank 1.3L

Rectangular Sauna Humidifier (Water Volume 1.3L)
code: HP01-071

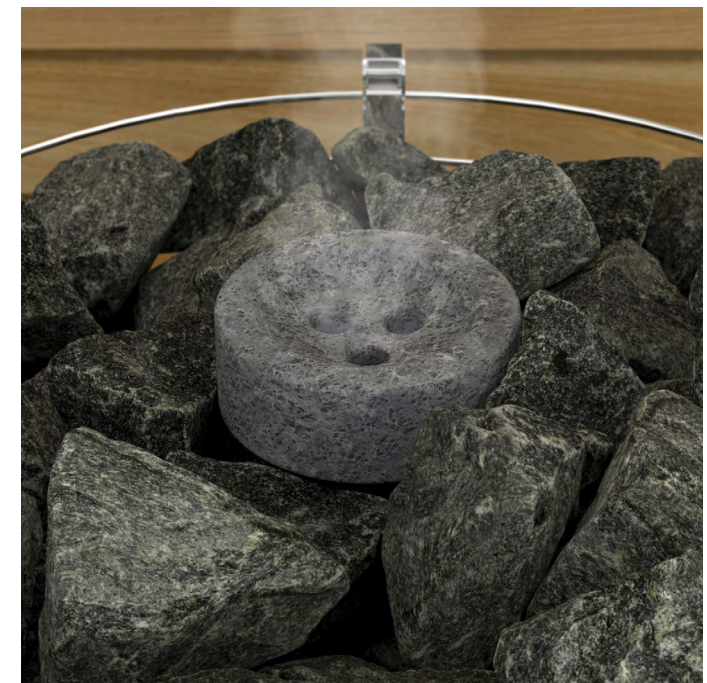



CONTROLS

Pleasurable moments are just few clicks away.

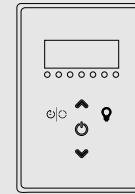

Saunova 2.0 (SAU-UI-V2)

- » Easy and stylish user interface
- » Direct control for Ni2 heaters, for NS heaters 2.3 - 9kW add Saunova 2.0
- » Power Controller
- » More than 9kW needs a Contactor
- » Smart Controlling - feature
- » Optional Fan and Combi - feature
- » Dimensions: (W) 104 x (H) 147 x (D) 37mm

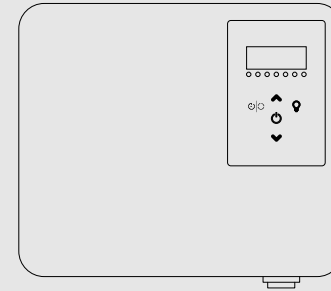

Saunova 2.0 Built-in (SAU-B-V2)

- » Combined User Interface and Power Controller
- » For all NS Heaters 2.3 - 9kW, for 9 - 18kW add Saunova 2.0 Contactor Unit
- » Smart Controlling - feature
- » Compatible with Door Sensor
- » Optional Fan and Combi - feature
- » Dimensions: (W) 270 x (H) 320 x (D) 90mm

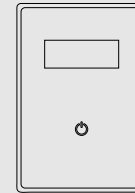

Saunova Simple (SAU-UI-S)

- » For those looking for simplicity on sauna controlling. Enables you to focus on the basics, turning the heater on / off.
- » Dimensions: (W) 104 x (H) 147 x (D) 37mm

Saunova 2.0 Power Controller (SAU-PC-V2)



Saunova 2.0 Contactor Unit (SAU-PS-V2)

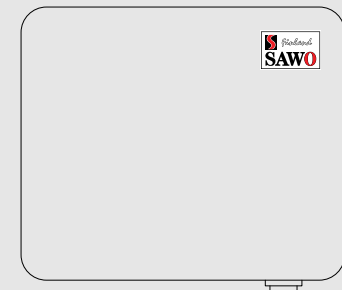

⚠ Needed when heater is more than 9kW power.

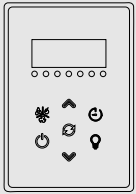

Innova Classic 2.0 (INC-S-V2)

- » Connect with INP-C-V2 to use with any NS-heater or use to directly control Ni-heaters
- » Smart Controlling - feature
- » Compatible with Door Sensor
- » Optional Fan, Dimmer and Combi-feature

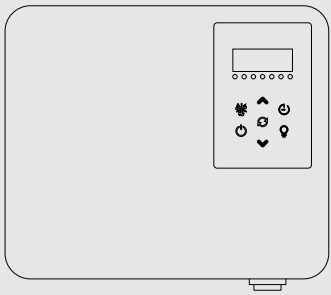

Innova Classic 2.0 Built-in (INC-B-V2)

- » Combined User Interface and Power Controller
- » For all NS Heaters 2.3 - 15kW, connect with Innova 2.0 Contactor Unit for 15 - 28kW heaters
- » Smart Controlling - feature
- » Optional Fan, Dimmer and Combi - feature
- » Dimensions: (L) 32cm x (H) 27cm x (W) 8cm



Innova Stainless Steel Touch (INT-S-SST)

- » Connect with INP-C to use with any NS-heater or use to directly control Ni-heaters
- » Smart Controlling - feature
- » Compatible with Door Sensor
- » Optional easy mode
- » Power blackout memory
- » Optional Fan, Dimmer and Combi - feature
- » Dimensions: (W) 147 x (H) 104 x (D) 40mm



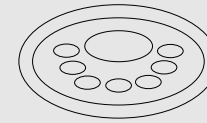

Innova Classic (INC-S)

- » Connect with INP-C to use with any NS-heater or use to directly control Ni-heaters
- » Smart Controlling - feature
- » Compatible with Door Sensor
- » Pre-run timer
- » Optional Fan, Dimmer and Combi - feature
- » Dimensions: (W) 180 x (H) 105 x (D) 31mm

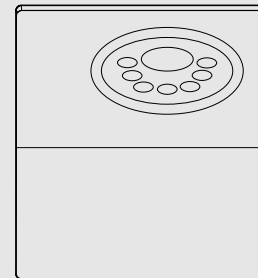

Innova Classic Built-in (INC-B)

- » Combined User Interface and Power Controller
- » For all NS Heaters 2.3 - 15kW, connect with Innova Contactor Unit for 15 - 28kW heaters
- » Smart Controlling - feature
- » Optional Fan, Dimmer and Combi - feature
- » Dimensions: (W) 245 x (H) 265 x (D) 75mm

Innova 2.0 Power Controller (INP-C)



Innova 2.0 Contactor Unit (INP-S)



⚠ A Contactor Unit is needed for more than 15kW power heater.

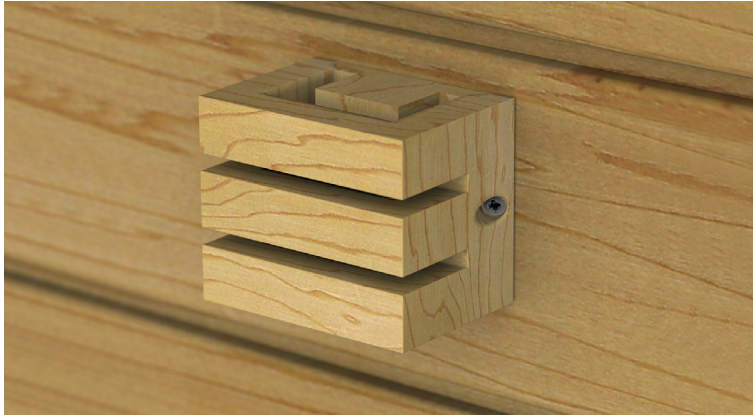

INCLUSIONS



RJ12 Cable



Temperature Sensor



Temperature Sensor with Fuse (INN-FTEMP)



OPTIONAL ITEMS

Interface Holders



» for Saunova 2.0, Classic 2.0, Stainless Steel Touch, Classic and Steam controls.

Temperature Sensors



Optional Second Temperature Sensor for Bench Area (INN-BTEMP)



Optional Humidity and Temperature Sensor for Bench Area (INN-HUM)

Sauna ACCESSORIES

Fulfill sauna design with outstanding sauna accessories.

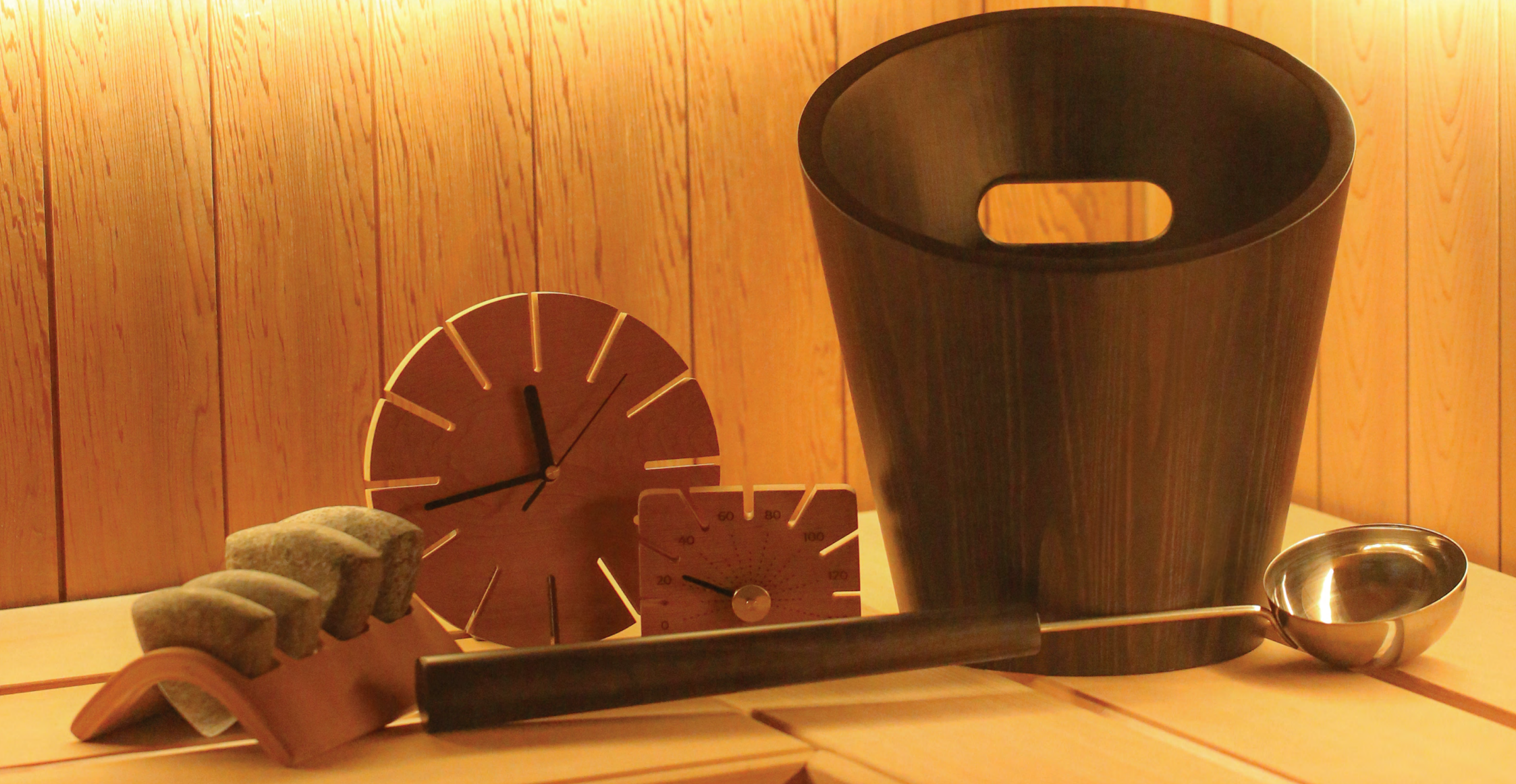



Usva
code: 374-MD | MA
capacity: 5L
wood: Cedar | Aspen



Stainless Pail with Curve Handle
code: 373-MA | MD
capacity: 5L
wood: Aspen | Cedar



Stainless Pail with Wooden Handle
code: 375-MP | MA | MD
capacity: 5L
wood: Pine | Aspen | Cedar



Kanto
code: 347-P | 347-WH | 347-BL
capacity: 4L
wood: Pine | White Pine | Black Pine



Lovi
code: 346-P | 346-WH | 346-BL
capacity: 4L
wood: Pine | White Pine | Black Pine



Dragon Pail
code: 342-D | 342-BL
capacity: 4L
wood: Cedar | Black Pine



Wooden Pail Traditional
code: 300-TP | TA | TD
capacity: 9L
wood: Pine | Aspen | Cedar



Wooden Pail Rattan
code: 341-P | A | D
capacity: 4L
wood: Pine | Aspen | Cedar



Wooden Pail Rattan
code: 300-HP | HA | HD
capacity: 9L
wood: Pine | Aspen | Cedar



Wooden Pail Rattan with Stainless Insert
code: 371-MP | MA | MD
capacity: 5L
wood: Pine | Aspen | Cedar



Wooden Pail Classic
code: 340-P | A | D
capacity: 4L
wood: Pine | Aspen | Cedar



Steamwater Pail 4L
code: 342-BL-DRF | 342-D-DRF
capacity: 4L
wood: Black Pine | Cedar



Steamwater Pail 9L
code: 300-BL-DRF | 300-D-DRF
capacity: 9L
wood: Black Pine | Cedar



Wooden Pail 18L
code: 381-P | A | D
capacity: 18L
wood: Pine | Aspen | Cedar



Wooden Cover for 381
code: 381-P-COV | A-COV | D-COV
use: Cover for 381 pail
wood: Pine | Aspen | Cedar



Wooden Pail 28L
code: 391-P | A | D
capacity: 28L
wood: Pine | Aspen | Cedar



Wooden Cover for 391
code: 391-P-COV | A-COV | D-COV
use: Cover for 391 pail
wood: Pine | Aspen | Cedar



Wooden Pail 40L
code: 392-P | A | D
capacity: 40L
wood: Pine | Aspen | Cedar



Wooden Cover for 392
code: 392-P-COV | A-COV | D-COV
use: Cover for 392 pail
wood: Pine | Aspen | Cedar

PAIL Shower

The **pail shower** is with a rope on the lever, hose and float valve. Its arc shaped holder design gives more possibilities to place shower either on the ceiling or to the wall. Pail shower is suitable for indoor or outdoor use. The hose needs to be connected to a water inlet so when water is flushed out, the pail will automatically be refilled – a never ending pail shower!



Pail Shower

code: 393-D | S | BL
capacity: 18L
wood: Cedar | Spruce | Black



Wall Installation



Ceiling Installation





SAUNA ACCESSORIES



Wooden Ladle Classic 41cm
code: 440 | D
size: 410mm
wood: Basswood | Cedar



Wooden Ladle Classic 52cm
code: 443 | D
size: 520mm
wood: Basswood | Cedar



Wooden Ladle Classic 68cm
code: 444 | D
size: 680mm
wood: Basswood | Cedar



Stainless Ladle 400mm
code: 441-MP | MA | MD
size: 400mm
wood: Pine | Aspen | Cedar



Brushed Steel Ladle Usva
code: 442-MP | MA | MD
size: 400mm
wood: Pine | Aspen | Cedar

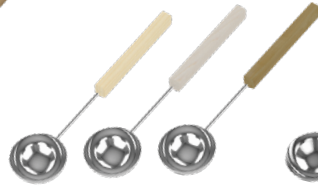

Stainless Ladle Siro 46.5cm
code: 445-MP | MA | MD
size: 465mm
wood: Pine | Aspen | Cedar



Stainless Ladle Siro 70.5cm
code: 446-MP | MA | MD
size: 705mm
wood: Pine | Aspen | Cedar



Stainless Ladle Huuru
40cm
code: 452-MP | 452-MA | 452-MD
size: 400mm
wood: Pine | Aspen | Cedar



Stainless Ladle Curve
code: 453-MD | 453-MA
size: 460mm
wood: Cedar | Aspen



Dragon Ladle
code: 449-D | BL
size: 498mm
wood: Cedar | Black



Steamshot Ladle
code: 449-BL-DRF | 449-D-DRF
size: 498mm
wood: Black | Cedar



Kanto Ladle
code: 451-MBL | 451-MWH | 451-MD
size: 520mm
wood: Black | White | Pine



THERMOMETERS & COMBINED METERS



Thermometer Loisto Square
code: 108-TD
size: 110 x 85mm
wood: Cedar



Thermometer Loisto Rounded
code: 109-TD
size: 110 x 85mm
wood: Cedar



Thermometer Black Metal
code: 295-TMD
size: 110 x 110mm
material: Black Metal / Cedar



Thermometer Kanto
code: 104-TD | 104-TWH | 104-TBL
size: 125 x 125mm
material: Cedar | White | Black



Thermo-Hygrometer Black Metal
code: 295-THMD
size: 220 x 110mm
material: Black Metal / Cedar



Thermometer Square
code: 223-TP | TA | TD
size: 140 x 140mm
wood: Pine | Aspen | Cedar



Thermo-Hygrometer Rectangle
code: 224-THP | THA | THD
size: 255 x 140mm
wood: Pine | Aspen | Cedar



Thermometer Cut Corner Square
code: 220-TP | TA | TD
size: 140 x 140mm
wood: Pine | Aspen | Cedar



Thermo-Hygrometer Square
code: 225-THP | THA | THD
size: 180 x 180mm
wood: Pine | Aspen | Cedar



Thermo-Hygrometer Curved Square
code: 285-THP | THA | THD
size: 170 x 175mm
wood: Pine | Aspen | Cedar



Thermo-Hygrometer Basic Curved Rectangle
code: 271-THBP | THBA | THBD
size: 225 x 140mm
wood: Pine | Aspen | Cedar



Thermo-Hygrometer Cut Corner Rectangle
code: 221-THP | THA | THD
size: 225 x 140mm
wood: Pine | Aspen | Cedar



Thermo-Hygrometer Cut Corner Vertical Rectangle
code: 221-THVP | THVA | THVD
size: 125 x 200mm
wood: Pine | Aspen | Cedar



Thermo-Hygrometer Rounded Rectangle
code: 222-THP | THA | THD
size: 225 x 140mm
wood: Pine | Aspen | Cedar



Thermo-Hygrometer Curved Rectangle
code: 271-THP | THA | THD
size: 225 x 140mm
wood: Pine | Aspen | Cedar



Thermo-Hygrometer Octagon
code: 241-THP | THA | THD
size: 175 x 225mm
wood: Pine | Aspen | Cedar



Thermo-Hygrometer Drop
code: 251-THP | THA | THD
size: 185 x 225mm
wood: Pine | Aspen | Cedar



Thermometer Accent Stone
code: 280-TRP | TRA | TRD
size: 125 x 160mm
wood: Pine | Aspen | Cedar



Thermo-Hygrometer Accent Stone Vertical
code: 283-THVRP | THVRA | THVRD
size: 155 x 255mm
wood: Pine | Aspen | Cedar



Thermometer Octagon
code: 240-TP | TA | TD
size: 165 x 180mm
wood: Pine | Aspen | Cedar



Thermo-Hygrometer Circle
code: 231-THP | THA | THD
size: Ø 185 x H 30mm
wood: Pine | Aspen | Cedar



Thermo-Hygrometer Accent Stone
code: 282-THRP | THRA | THRD
size: 255 x 155mm
wood: Pine | Aspen | Cedar



Thermo-Hygrometer Accent Stone
code: 281-THRP | THRA | THRD
size: 160 x 185mm
wood: Pine | Aspen | Cedar



Thermometer Drop
code: 250-TP | TA | TD
size: 150 x 180mm
wood: Pine | Aspen | Cedar



Thermometer Circle
code: 230-TP | 230-TA | 230-TD
size: Ø135 x H30mm
wood: Pine | Aspen | Cedar



CLOCKS & TIMERS



Loisto Clock
Square

code: 534-D
size: 180 x 180mm
wood: Cedar



Loisto Clock
Round

code: 535-D
size: Ø180mm
wood: Cedar



Wooden Pail
Clock

code: 530-P | 530-A | 530-D
size: Ø260 x H90mm
wood: Pine | Aspen | Cedar



Wooden Pail
Clock Small

code: 531-P | 531-A | 531-D
size: Ø230 x H40mm
wood: Pine | Aspen | Cedar



Sand Timer
15min

code: 554-BL
size: 58 x 340mm
wood: Black Cedar



Sand Timer
15min

code: 550-P | 550-A | 550-D
size: 65 x 340mm
wood: Pine | Aspen | Cedar



Sand Timer
15min with Stone

code: 550-RP | 550-RA | 550-RD
size: 65 x 340mm
wood: Pine | Aspen | Cedar



Sand Timer
Classic 15min

code: 551-P | 551-A | 551-D
size: 65 x 340mm
wood: Pine | Aspen | Cedar



Sand Timer
15min

code: 553-P | 553-A | 553-D
size: 80 x 340mm
wood: Pine | Aspen | Cedar



HEADRESTS & BACKRESTS



Wave
Wooden Backrest

code: 506-2-A | D
size: 390 x 845mm
wood: Aspen | Cedar



Wave
Wooden Headrest

code: 515-A | D
size: 190 x 480mm
wood: Aspen | Cedar



Halu
Wooden Headrest

code: 512-A | D
size: 180 x 230mm
wood: Aspen | Cedar



Halu
Anti-theft Headrest

code: 513-A | D
size: 190 x 480mm
wood: Aspen | Cedar



Wooden
Backrest

code: 516-P | A | D
size: 396 x 515mm
wood: Pine | Aspen | Cedar



Wooden
Backrest

code: 514-A | D
size: 346 x 888mm
wood: Aspen | Cedar

BENCHES



Siro Sauna Bench
code: 528-D
size: 440 x 290 x 400mm
wood: Cedar



Siro Sauna Bench
code: 529-D
size: 750 x 290 x 400mm
wood: Cedar



Sauna Bench
code: 520-D
size: 534 x 430 x 400mm
wood: Cedar



Sauna Bench
code: 521-D
size: 870 x 430 x 400mm
wood: Cedar



Sauna Bench
code: 522-D
size: 870 x 500 x 500mm
wood: Cedar



Sauna Bench
code: 523-D
size: 1200 x 500 x 500mm
wood: Cedar



Sauna Bench 2-Steps
code: 524-D
size: 530 x 780 x 850mm
wood: Cedar



WOODEN CLOTH HANGERS



Wooden Cloth Hanger - 3 Holders
code: 582-P | A | D
size: 42 x 240mm
wood: Pine | Aspen | Cedar



Wooden Cloth Hanger - 4 Holders
code: 586-P | A | D
size: 42 x 340mm
wood: Pine | Aspen | Cedar



Wooden Cloth Hanger - 5 Holders
code: 583-P | A | D
size: 42 x 440mm
wood: Pine | Aspen | Cedar

FLOOR MAT TILES



Wooden Floor Mat Block
code: 595-D-BC | 595-A-BC | 595-GO-BC
size: 285 x 285mm
thickness: 22mm
wood: Cedar | Aspen | Hardwood



Wooden Floor Mat Corner Frame
code: 595-D-CNR | 595-A-CNR | 595-GO-CNR
size: 390 x 115mm
thickness: 22mm
wood: Cedar | Aspen | Hardwood



Wooden Floor Mat Middle Frame
code: 595-D-SID | 595-A-SID | 595-GO-SID
size: 285 x 115mm
thickness: 22mm
wood: Cedar | Aspen | Hardwood

COVERS FOR SAUNA LIGHT



Wooden Light Cover Square
code: 910-SP | SA | SD
size: 250 x 75mm
wood: Pine | Aspen | Cedar



Wooden Light Cover Square
code: 911-LP | LA | LD
size: 250 x 135mm
wood: Pine | Aspen | Cedar



Wooden Light Cover Corner/Wall
code: 914-VP | VA | VD
size: 150 x 110mm
wood: Pine | Aspen | Cedar



Wooden Light Cover Wave
code: 917-A | D
size: 207 x 280mm
wood: Aspen | Cedar

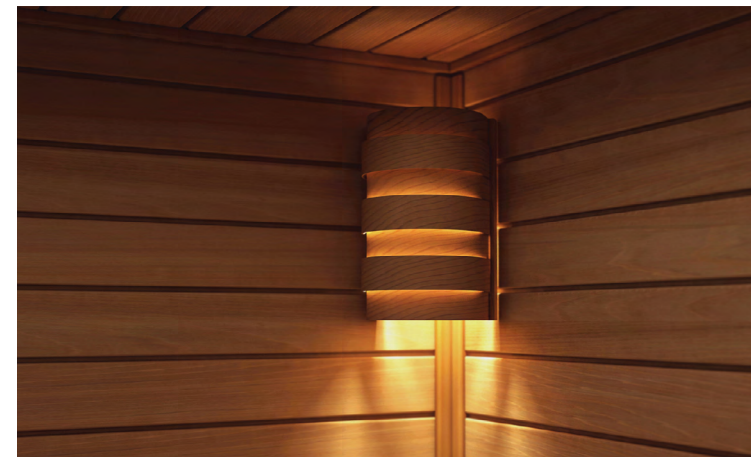



DOOR HANDLES



Wooden Arc Door Handle
code: 558-A | D
size: 40 x 900mm
wood: Aspen | Cedar

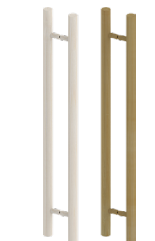

Wooden Straight Door Handle
code: 559-A | D
size: 36 x 900mm
wood: Aspen | Cedar



Wooden Straight Door Handle with metal Accent
code: 560-A | D | BL
size: 155 x 900mm
wood: Aspen | Cedar | Black



Wooden Door Handle Small Round
code: 565-P | A | D
size: Ø65 x W70mm
wood: Pine | Aspen | Cedar



Wooden Door Handle Big Round
code: 566-P | A | D
size: Ø90 x W50mm
wood: Pine | Aspen | Cedar



Wooden Door Handle with Magnetic Lock
code: 568-P | A | D
size: 260 x 45mm
wood: Pine | Aspen | Cedar



Door Hinge Round
code: 571 | 571-BL
size: 90 x 70mm
material: Aluminum



Door Lock Magnet Round, Heavy-Duty
code: 574
size: 17 x 28.5mm
material: Aluminum



VENTILATIONS



Ventilation Louver Square
code: 620-P | A | D
size: 215 x 170mm
wood: Pine | Aspen | Cedar



Ventilation Louver Circle
code: 631-P | A | D
size: Ø145mm
wood: Pine | Aspen | Cedar
ducting hole: 100mm



Ventilation Louver Circle
code: 634-P | A | D
size: Ø170mm
wood: Pine | Aspen | Cedar
ducting hole: 125mm



Ventilation Louver Circle
code: 638-P | A | D | BL
size: Ø145mm
wood: Pine | Aspen | Cedar
ducting hole: 100mm



Ventilation Louver Circle
code: 639-P | A | D | BL
size: Ø170mm
wood: Pine | Aspen | Cedar
ducting hole: 125mm



Coaster / Bottle Opener
code: 581-P | A | D
size: Ø80mm
wood: Pine | Aspen | Cedar



Sauna Signage
code: 950-P | A | D
size: 150 x 80mm
wood: Pine | Aspen | Cedar



Moisture Paper
code: SP02-900
size: 1,200mm x 77mm x 77mm



DISPLAY STAND WALL



Display Stand Wall 1
code: DP-15
size: (W)1110 x (D)630 x (H)2000mm



Display Stand Wall 2
code: DP-16
size: (W)2300 x (D)630 x (H)2000mm



Display Stand Wall 3
code: DP-17
size: (W)3400 x (D)630 x (H)2000mm

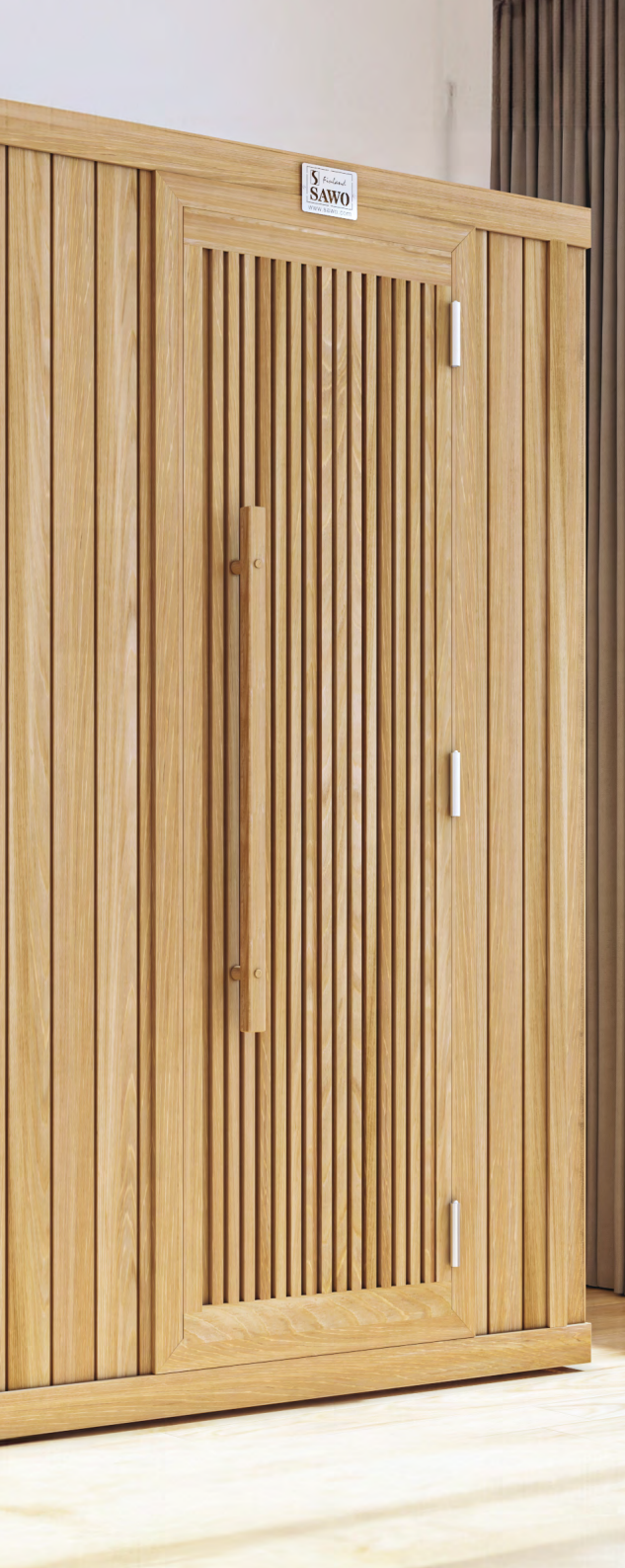

DOOR SETS



**Wooden Stripe
Sauna Door**
code: 770-4SD-R | L
Wooden size: 610 x 1935mm
Frame size: 700 x 2040mm
wood: Cedar



**Wooden Stripe
Sauna Door**
code: 771-4SD-R L
Wooden size: 915 x 2015mm
Frame size: 1005 x 2120mm
wood: Cedar



Wooden Reversible Sauna Door
code: 773-4SD | 734-4SD | 734-4SD
Wooden size: 915 x 2015mm
Frame size: 1005 x 2120mm
wood: Cedar | Aspen | Spruce



Wooden Reversible Sauna Door
code: 734-4SD | 734-4SD | 734-4SD
Wooden size: 610 x 1935mm
Frame size: 700 x 2040mm
wood: Cedar | Aspen | Spruce



**Wooden Door with
Clear Glass Window**
code: 743-4SCD-R | L / 743-4SCA-R | L /
743-4SCU-R | L
Glass size: 600 x 1800mm
Frame size: 690 x 1890mm
wood: Cedar | Aspen | Spruce



**Wooden Door with
Bronze Glass Window**
code: 743-4SGD-R | L / 743-4SGA-R | L /
743-4SGU-R | L
Wooden size: 600 x 1800mm
Frame size: 690 x 1890mm
wood: Cedar | Aspen | Spruce



Wooden Sauna Door w/ Window
code: 736-4SGD-R | L /
736-4SGD-R | L
Wooden size: 915 x 2015mm
Frame size: 1005 x 2120mm
wood: Aspen | Cedar



**Wooden Wide Clear Window
Sauna Door**
code: 739-3SCA-R | L /
739-3SCD-R | L
Frame size: 124 x 1003 x 2075mm
wood: Aspen | Cedar



**Wooden Wide Bronze Window
Sauna Door**
code: 739-3SGA-R | L /
739-3SGD-R | L
Frame size: 124 x 1005 x 2075mm
wood: Aspen | Cedar



Clear Glass Reversible Sauna Door

code: 730-4SCP | 730-4SCA | 730-4SCD
 Glass size: 600 x 1800mm
 Frame size: 690 x 1890mm
 wood: Pine | Aspen | Cedar



Clear Glass Reversible Sauna Door

code: 731-4SCP | 731-4SCA | 731-4SCD
 Glass size: 700 x 1800mm
 Frame size: 790 x 1890mm
 wood: Pine | Aspen | Cedar



Clear Glass Reversible Sauna Door
 w/ Wooden Handle Arc

code: 741-4SCD-1 | 741-4SCA-1
 Glass size: 600 x 1800mm
 Frame size: 690 x 1890mm
 wood: Aspen | Cedar

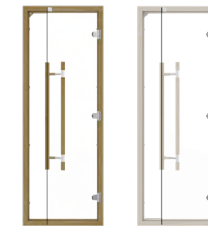

Clear Glass Reversible Sauna Door
 w/ Wooden Handle Metal

code: 741-4SCD-3 | 741-4SCA-3
 Glass size: 600 x 1800mm
 Frame size: 690 x 1890mm
 wood: Aspen | Cedar



Bronze Glass Reversible Sauna Door
 w/ Arc Handle

code: 741-4SGD-1 | 741-4SGA-1
 Glass size: 600 x 1800mm
 Frame size: 690 x 1890mm
 wood: Cedar | Aspen



Bronze Glass Reversible Sauna Door
 w/ Metallic Handle

code: 741-4SGD-3 | 741-4SGA-3
 Glass size: 600 x 1800mm
 Frame size: 690 x 1890mm
 wood: Cedar | Aspen



Bronze Glass Reversible Sauna Door Standard

code: 730-4SGP | 730-4SGA | 730-4SGD
 Glass size: 600 x 1800mm
 Frame size: 690 x 1890mm
 wood: Pine | Aspen | Cedar



Bronze Glass Reversible Sauna Door Standard

code: 731-4SGP | 731-4SGA | 731-4SGD
 Glass size: 700 x 1800mm
 Frame size: 790 x 1890mm
 wood: Pine | Aspen | Cedar

Left-handed Bronze Glass Sauna Door
 Finland w/ Arc Handle

code: 741-3SGD-L-1 | 741-3SGA-L-1
 Glass size: 600 x 1800mm
 Frame size: 690 x 1890mm
 wood: Cedar | Aspen

Left-handed Bronze Glass Sauna Door
 Finland w/ Metallic Handle

code: 741-3SGD-L-3 | 741-3SGA-L-3
 Glass size: 600 x 1800mm
 Frame size: 690 x 1890mm
 wood: Cedar | Aspen

Left-handed Bronze Glass Sauna Door Finland

code: 730-3SGP-L | 730-3SGA-L | 730-3SGD-L
 Glass size: 600 x 1800mm
 Frame size: 690 x 1890mm
 wood: Pine | Aspen | Cedar

Left-handed Bronze Glass Sauna Door Finland

code: 731-3SGP-L | 731-3SGA-L | 731-3SGD-L
 Glass size: 700 x 1800mm
 Frame size: 790 x 1890mm
 wood: Pine | Aspen | Cedar

Right-handed Bronze Glass Sauna Door
 Finland w/ Arc Handle

code: 741-3SGD-R-1 | 741-3SGA-R-1
 Glass size: 600 x 1800mm
 Frame size: 690 x 1890mm
 wood: Cedar | Aspen

Right-handed Bronze Glass Sauna Door
 Finland w/ Metallic Handle

code: 741-3SGD-R-3 | 741-3SGA-R-3
 Glass size: 600 x 1800mm
 Frame size: 690 x 1890mm
 wood: Cedar | Aspen

Right-handed Bronze Glass Sauna Door Finland

code: 730-3SGP-R | 730-3SGA-R | 730-3SGD-R
 Glass size: 600 x 1800mm
 Frame size: 690 x 1890mm
 wood: Pine | Aspen | Cedar

Right-handed Bronze Glass Sauna Door Finland

code: 731-3SGP-R | 731-3SGA-R | 731-3SGD-R
 Glass size: 700 x 1800mm
 Frame size: 790 x 1890mm
 wood: Pine | Aspen | Cedar

KIVISTONE®

Kivistone is a collection of beautiful products carved from Finnish soapstone. Each of these items are uniquely designed for house interiors, household use and for personal or corporate gifts. You will find a vast selection of interesting concepts and designs made of soapstone.

- » Coolers and cooler sets
- » Aroma cups and scent basins
- » Miscellaneous items



SAUNA ACCESSORIES



Wine Cooler Stone
code: R-93-D
size: 230 x 155 x 84mm
material: Soapstone/Cedar



Spa Stones Set
code: R-500-D
size: 90 x 128 x 178mm
material: Soapstone/Cedar



Cooler (1 hole)
code: R-141
size: 100 x 100 x 75mm
weight: 1,3kG



Cooler (2 holes)
code: R-92
size: 185 x 100 x 75mm
weight: 4,1kG



Cooler w/ 2 shot glasses
code: R-205
size: 135 x 100 x 70mm
weight: 1,8kG



Cooler w/ 4 shot glasses
code: R-206
size: 190 x 120 x 70mm
weight: 2,3kG



Luxury Aroma Cup (ø)50
code: R-160
size: 50 x 50 x 50mm
weight: 0,2kG



Aroma Cup (ø)50
code: R-100
size: 50 x 50 x 60mm
weight: 0,3kG



Aroma Spirit Cup
code: R-501
size: 75 x 75 x 120mm
weight: 0,7kG



Scent Warmer
code: R-123
size: 75 x 75 x 80mm
weight: 0,7kG



Candle Holder Tower
code: R-131
size: 60 x 60 x 60mm
weight: 0,6kG



Candle Holder Tower
code: R-132
size: 60 x 60 x 90mm
weight: 0,9kG



Candle Holder Tower
code: R-133
size: 60 x 60 x 120mm
weight: 1,2kG



Tower Set 3
code: R-125
size: 180 x 60 x 180mm
weight: 1,8kG



Candle Holder Straight
code: R-105
size: 265 x 60 x 30mm
weight: 1,3kG



Plate w/ 3 shot glasses
code: R-151
size: 240 x 170 x 35mm
weight: 2,7kG



Stone Plate Small
code: R-152
size: 240 x 170 x 25mm
weight: 2,8kG



Stone Plate Large
code: R-153
size: 305 x 200 x 15mm
weight: 2,8kG



Ashtray
code: R-407
size: 60 x 50 x 60mm
weight: 0,7kG



Soap Holder
code: R-116
size: 180 x 100 x 30mm
weight: 0,9kG

STEAM Sauna

Unwind stress with soothing clouds.

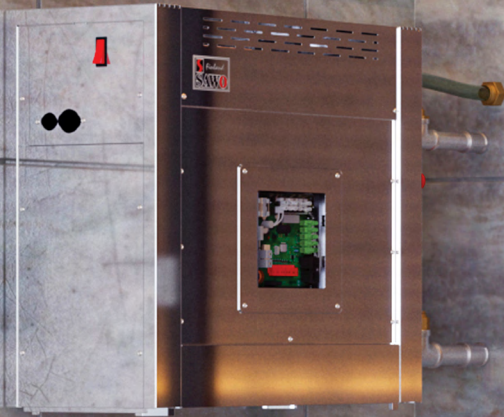



STE-W Steam Generator

STE-W Steam generators are best for residential use. It has straight forward functions that is very easy to operate by switching on the control and adjusting the temperature knob. Now the updated design with removable side window for easier changing of settings on the board. It can be installed that the steam outlet be facing left or right at any convenient position.

SAWO steam generators can be tapped up to 5 series connections to have maximum power output using only 1 control. Maximum power output is 75kW.

ⓘ For more technical information, see page 85.



2 Heating Elements

- » Steam output up to 6,7kg/hr
- » Can be installed in either side
- » Own pipe for overpressure valve
- » Steam head included
- » 3kW - 5kW power



3 Heating Elements

- » Steam output up to 7,5kg/hr
- » Can be installed in either side
- » Own pipe for overpressure valve
- » Steam head included
- » 4,5kW - 7,5kW power



6 Heating Elements

- » Steam output up to 20kg/hr
- » Can be installed in either side
- » Own pipe for overpressure valve
- » Steam head included
- » 9kW - 15kW power

STN-W Steam Generator

A more robust and heavy-duty performer **STN-W steam generator** is best for commercial use. Comes with unique cassette for heating elements for easy cleaning and replacement. Use the Aroma, Fan and dimmer features to customize the steam sauna experience to your liking. Demand button can be installed to release extra steam for 30 seconds. Troubleshooting becomes very handy as error codes are displayed on the controller screen. Now the updated design with removable side window for easier changing of settings on the board. These steam generators can be installed in any favorable left or right orientation. The autodrain is possible to be installed on the side or on the bottom.

SAWO steam generators can be tapped up to 5 series connections to have maximum power output using only 1 control. Maximum power output is 75kW.

! For more technical information, see page 85.



2 Heating Elements



- » Steam output up to 6,7kg/hr
- » Can be installed in either side
- » Own pipe for overpressure valve
- » Auto drain
- » Steam head included
- » Cassette type heating element setup for easy maintenance
- » 3kW - 5kW power
- » ¾" steam pipe
- » Stainless Touch & STW 2.0

3 Heating Elements



- » Steam output up to 7,5kg/hr
- » Can be installed in either side
- » Own pipe for overpressure valve
- » Auto drain
- » Steam head included
- » Cassette type heating element setup for easy maintenance
- » 4,5kW - 7,5kW power
- » ¾" steam pipe
- » Stainless Touch & STW 2.0

6 Heating Elements



- » Steam output up to 20kg/hr
- » Can be installed in either side
- » Own pipe for overpressure valve
- » Auto drain
- » Steam head included
- » Cassette type heating element setup for easy maintenance
- » 9kW - 15kW power
- » ¾" steam pipe
- » Stainless Touch & STW 2.0

Technical DATA

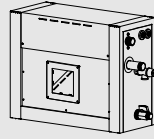

STE-W Steam Generator

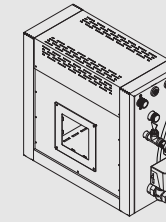

STN-W Steam Generator

2 Heating Elements

STEAM GENERATOR MODEL	kW	STEAM ROOM (m³)		SIZE OF STEAM GENERATOR			WEIGHT (KG)	CONTROL
		MIN	MAX	WIDTH	DEPTH (mm)	HEIGHT		
STE-W-30-1/2	3,0		3	555	275	465	16,5	STE-W 2.0
STE-W-35-1/2	3,5		3,5	555	275	465	16,5	STE-W 2.0
STE-W-40-1/2	4,0		4	555	275	465	16,5	STE-W 2.0
STE-W-45-1/2	4,5	2	5	555	275	465	16,5	STE-W 2.0
STE-W-50-1/2	5,0	2	6	555	275	465	16,5	STE-W 2.0

3 Heating Elements

STEAM GENERATOR MODEL	kW	STEAM ROOM (m³)		SIZE OF STEAM GENERATOR			WEIGHT (KG)	CONTROL
		MIN	MAX	WIDTH	DEPTH (mm)	HEIGHT		
STE-W-45-C1/3	4,5	2	5	555	320	370	18	STE-W 2.0
STE-W-60-C1/3	6,0	3	10	555	320	370	18	STE-W 2.0
STE-W-75-C1/3	7,5	4	15	555	320	370	18	STE-W 2.0

6 Heating Elements

STEAM GENERATOR MODEL	kW	STEAM ROOM (m³)		SIZE OF STEAM GENERATOR			WEIGHT (KG)	CONTROL
		MIN	MAX	WIDTH	DEPTH (mm)	HEIGHT		
STE-W-90-C1/3	9,0	8	20	555	405	465	23	STE-W 2.0
STE-W-120-3	12,0	15	28	555	405	465	23	STE-W 2.0
STE-W-150-3	15,0	22	40	555	405	465	23	STE-W 2.0

2 Heating Elements

STEAM GENERATOR MODEL	kW	STEAM ROOM (m³)		SIZE OF STEAM GENERATOR			WEIGHT (KG)	CONTROL
		MIN	MAX	WIDTH	DEPTH (mm)	HEIGHT		
STN-W-30-1/2	3,0		3	560	245	485	17	Stainless Touch STN-W 2.0
STN-W-35-1/2	3,5		3,5	560	245	485	17	Stainless Touch STN-W 2.0
STN-W-40-1/2	4,0		4	560	245	485	17	Stainless Touch STN-W 2.0
STN-W-45-1/2	4,5	2	5	560	245	485	17	Stainless Touch STN-W 2.0
STN-W-50-1/2	5,0	2	6	560	245	485	17	Stainless Touch STN-W 2.0

3 Heating Elements

STEAM GENERATOR MODEL	kW	STEAM ROOM (m³)		SIZE OF STEAM GENERATOR			WEIGHT (KG)	CONTROL
		MIN	MAX	WIDTH	DEPTH (mm)	HEIGHT		
STN-W-45-3	4,5	2	5	560	280	485	19	Stainless Touch STN-W 2.0
STN-W-45-C1/3	4,5	2	5	560	280	485	19	Stainless Touch STN-W 2.0
STN-W-60-3	6,0	3	10	560	280	485	19	Stainless Touch STN-W 2.0
STN-W-60-C1/3	6,0	3	10	560	280	485	19	Stainless Touch STN-W 2.0
STN-W-75-3	7,5	4	15	560	280	485	19	Stainless Touch STN-W 2.0
STN-W-75-C1/3	7,5	4	15	560	280	485	19	Stainless Touch STN-W 2.0

6 Heating Elements

STEAM GENERATOR MODEL	kW	STEAM ROOM (m³)		SIZE OF STEAM GENERATOR			WEIGHT (KG)	CONTROL
		MIN	MAX	WIDTH	DEPTH (mm)	HEIGHT		
STN-W-90-3	9,0	8	20	560	375	485	23	Stainless Touch STN-W 2.0
STN-W-90-C1/3	9,0	8	20	560	375	485	23	Stainless Touch STN-W 2.0
STN-W-120-3	12,0	15	28	560	375	485	23	Stainless Touch STN-W 2.0
STN-W-150-3	15,0	22	40	560	375	485	23	Stainless Touch STN-W 2.0

INCLUDED IN THE PACKAGE



Autodrain
(Included for STN models only)



Aroma, Fan and Dimmer Functions
(Optional features for STN models)



Temperature sensor with wire and sensor holder



Steam Head



7,5m RJ12 Cable
7,5m RJ45 Cable

STEAM GENERATOR Controls

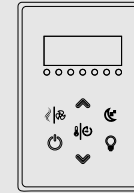

Steam 2.0 (STP-INFACE-V2)

- » Thick stainless steel casing
- » LED digital display
- » Optional features: light dimmer, scent pump and fan
- » 7.5 meters RJ12 cable with connectors included

Steam Stainless Touch (STP-INFACE-SST)

- » Thick stainless steel casing
- » Animated buttons
- » Compatible for automated household component
- » Emergency alarm provision
- » Standby mode to keep water warm until next session
- » Displays error code
- » Autodrain function
- » Key lock
- » Easy mode available
- » Date and time setup
- » Kilowatt usage counter
- » Decalcifying function
- » Heating Element fail detect
- » Blackout memory
- » Celsius or Fahrenheit temperature unit
- » Autolight
- » Autofan
- » LCD contrast adjustment
- » Optional scent pump, light dimmer and fan
- » Temperature sensor with wire
- » Optional interface holder
- » 7.5 meters RJ12 cable with connectors included

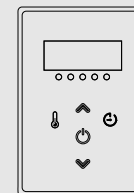

Steam STE (STE-INFACE-V2)

- » Thick stainless steel casing
- » LED digital display
- » Optional features: light dimmer, scent pump and fan
- » 7.5 meters RJ12 cable with connectors included

OPTIONAL ITEMS



Aroma Pump



Demand Button



Steam Door
code: ST-746
size: 790 x 1890mm



Steam Door
code: ST-749
size: 900 x 2100mm

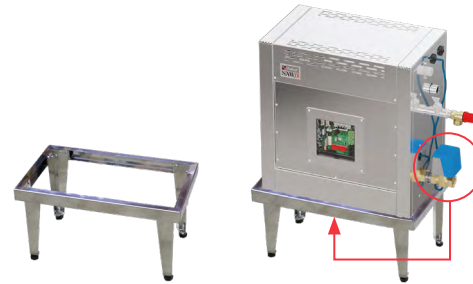

Installation Stand for STW
code: STW-STAND

- » For easier installation of STW steam generator

VENTURI PIPE



Venturi Pipe L-shape



Venturi Pipe Straight

Venturi Pipe

- » Generate milder and softer steam
- » Create more steam clouds
- » Prevents hissing noise
- » Including steam head to spread the steam outburst
- » Thick stainless metal





www.sawo.com

 [SAWO International](#)

 [SAWO - Sauna World](#)

 [SAWO Inc.](#)

 [SAWO Sauna World](#)

 [SAWOSauna](#)